



THE DOOR OF BEAUTY & INNOVATION





We choose a door for its aesthetic qualities, but doors offer so much more than aesthetics. Your front door is a warm familiar place where new guests arrive and a cheerful announcement when friends come. We live our lives through them. Our front door sees us when we start our day and are ready to take on new opportunities. It's also a gentle embrace at the end of the day, welcoming us to our home and family. Doors aren't just doors; they're a reflection of us and our home. They help us and our families feel safe and protected. We know how important it is to choose a door that best represents you, makes you feel secure, and fits your needs.

ABOUT PLASTPRO

Since 1994, Plastpro has always believed in providing a superior product with the best value, technology, and commitment to our customers. Our fiberglass doors offer the beauty and versatility of wood doors, but require less maintenance and have a longer lifespan. Wood and steel doors have been preferred in the industry, but both come with problems such as: rotting, rusting, and weather damage. Our fiberglass doors are the best solution and are not susceptible to weather damage, require less maintenance, and offer higher performance ratings. We've introduced the first door with composite stiles and rails, HydroShield technology, and composite Polyfiber (PF) Frames to the industry. Our doors feature a full length LVL block that provides stronger rigidity and a range of door locks and hardware to be installed for increased security. We carry a wide variety of designs, sizes, and styles that are bound to complement everyone's home.







Since the beginning, we've not only been committed to providing superior products, but also in creating opportunities. Our goal is to create positive changes for not only our employees and customers, but also for our community. We believe in doing good for the world and making a difference. For us, success is only as good as the good it creates. We've continuously partnered with Habitat for Humanity in order to create affordable, green houses for low-income families across the nation. We've donated more than 500 doors to various chapters of Habitat for Humanity and other non-profit organizations. When you buy a Plastpro door, you not only get a beautiful door with the best quality, you become part of Plastpro and join us in giving back to others.

TABLE OF CONTENTS

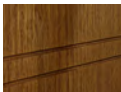
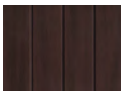
- 5 **PLASTPRO'S QUALITY**
- 6 - 9 **PF™ DOOR FRAMES**
- 10 **CHOOSING YOUR DOOR**
- 11 **DOORABILITY**

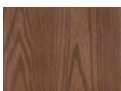
- 12 - 13 **DOOR SERIES OVERVIEW**
- 14 - 15 **SPECIALTY SERIES OVERVIEW** (FIRE RATED, HVHZ, TRIMABLE & RESIDENTIAL ADA)

- 16 - 23 **DOORLITE OVERVIEW - DECORATIVE GLASS**
- 24 - 27 **SOLUTION DOORLITE SERIES OVERVIEW**

28 - 33		LIMITED
34 - 41		MODERN
42 - 53		RUSTIC
54 - 61		MAHOGANY
62 - 69		FIR
70 - 99		OAK
100 - 143		SMOOTH
144 - 157		WHITE OAK
158 - 165		ONELITE
166 - 171		NOVA

- 172 - 175 **STAIN KIT & PAINT GUIDES**
- 176 **TESTING INFORMATION**
- 177 - 182 **PRODUCT INDEX**

PATENTED HYDROSHIELD™ TECHNOLOGY

Our exclusive HydroShield technology protects our doors against moisture and humidity infiltration, by creating a fully composite barrier that encases and protects the door on all six sides. It prevents warping, delamination, corrosion, rotting, and the buildup of mold and mildew. Our doors with HydroShield technology used with our Polyfiber (PF) Door Frames create an enhanced, impenetrable entryway.



1 FIBERGLASS REINFORCED DOOR SKINS

Our exclusive formula is measured precisely to ensure each skin is produced to the highest quality. With unlimited design options, customized panel configurations are possible. The skins require little maintenance and will not splinter, dent, warp, rot, or rust. They can be painted, stained, and we provide a variety of graining options.

2 FULL LENGTH COMPOSITE STILES

Our full-length composite stiles protect the door from external moisture to prevent warping or rotting. They have twice the screw-holding strength of wood.

3 COMPOSITE TOP & BOTTOM RAILS

High strength composite top and bottom rails prevent moisture from seeping into the door and stops the buildup of mold.

4 EXTENDED LOCKBLOCK

Plastpro's full length LVL allows any type of lock to be placed for increased security.

5 POLYURETHANE FOAM CORE

Our advanced CFC-free, high density, Polyurethane foam core enhances the door's soundproofing capabilities and provides insulation up to six times greater than wood doors.



BACKED BY WARRANTY

We are proud to offer one of the best warranties in the industry. Plastpro products are held to high standards. We stand behind our products and guarantee the best quality to meet your performance expectations.

PFT™ DOOR FRAMES

To have a complete entry system, it is important to consider the material of the door frame. Wood doors and frames are prone to warping, rotting, and cracking, while steel doors and frames can rust and dent. You don't want to install a door that will fail, nor do you want to install a frame that will fail.

Plastpro's Polyfiber (PF) Door Frames are a uniquely formulated and innovative alternative to traditional door frames. They combine the beauty of wood but require less maintenance and have a longer lifespan. The material is durable, long-lasting, and is more thermally resistant than either wood or metal. The advanced system can be installed the same way as traditional wood frames with no added hassle. When used together with a fiberglass door, they create an enhanced, impenetrable entryway.

FEATURES & BENEFITS

- Equipped with HydroShield technology, it will not absorb or wick moisture, and prevents warping, rotting, and splitting.
- Frame is not able to be infested with termites at any point along the structure.
- Has twice the screw holding power of traditional wood door frames.
- More versatility in design. Available in various lengths and widths that can be stained as well as painted.
- Maintenance free and energy efficient.
- Continuous piece with no finger joint and is 25% more rigid than wood frames.

FRAME DECAY COMPARISON



PLASTPRO PFT™ DOOR FRAME

*with Hydroshield Technology™



TRADITIONAL WOOD FRAME

Susceptible to rotting, warping and decay



4 5/16" DOOR JAMB



6 5/16" DOOR JAMB

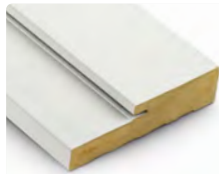

5 1/4" DOOR JAMB

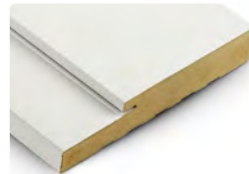

7 1/4" DOOR JAMB

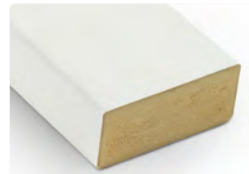

1 1/4" x 3" JAMB EXTENSION



WM180 BRICK MOULD

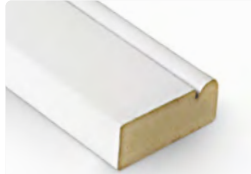

WM176 FL. BRICK MOULD



1" x 2" STUCCO MOULD

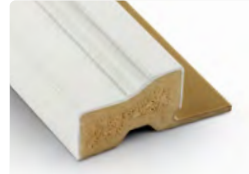

NAILING FIN

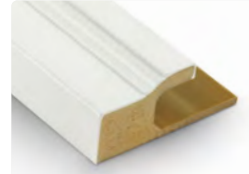

J-CHANNEL



FLAT CASING



FLAT CASING J-CHANNEL



TRIM BOARDS

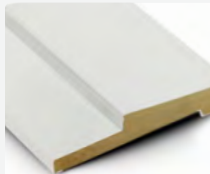

TRANSOM SILLS

- 4 5/16"
- 6 5/16"



MULL POSTS

- 1 1/2" x 3 3/16" x 2 1/2"
- 1 1/2" x 4 3/16" x 2 1/2"
- 1" x 3 3/16" x 2"
- 1" x 4 3/16" x 2"



MULL POST COVERS (EXT.)

- 1 1/2" x 1"
- 2" x 1"

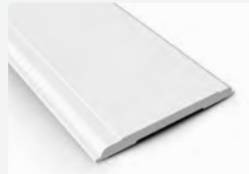

MULL POST CAP



STORM DOOR ADAPTERS

- 1" x 2 1/2"
- 1" x 3"



SIDELITE STOPPER



ASTRAGAL



PFT™ ARCH HEADERS



PFT™ RADIUS HEADERS



MATCHING DOOR	MATCHING KIT CODE	PRODUCT DIMENSION
DRA2C	PFG043068AK	4 ⁹ / ₁₆ " Arch Frame Kit*
	PFG063068AK	6 ⁹ / ₁₆ " Arch Frame Kit*
DRA2C80	PFG043080AK	4 ⁹ / ₁₆ " Arch Frame Kit*
	PFG063080AK	6 ⁹ / ₁₆ " Arch Frame Kit*
DRA2C80-36	PFG043680AK	4 ⁹ / ₁₆ " Arch Frame Kit*
	PFG063680AK	6 ⁹ / ₁₆ " Arch Frame Kit*

PFT™ FRAMES ARCH HEADER KIT

*ALL KITS INCLUDE BRICK MOULD

MATCHING DOOR	MATCHING KIT CODE	PRODUCT DIMENSION
DRA2F80	PFG04030H0RHK	4 ⁹ / ₁₆ " Radius Frame Kit*
	PFG06030H0RHK	6 ⁹ / ₁₆ " Radius Frame Kit*

PFT™ FRAMES RADIUS HEADER KIT

*ALL KITS INCLUDE BRICK MOULD

ARCH & RADIUS HEADER KITS

The shape of an arched and radius door isn't the only thing that makes it different from a traditional rectangular door. Arch doors exude style and give your entryway a brand new look. Plastpro is the only fiberglass door manufacturer able to offer full composite frames to match arch or radius top doors.

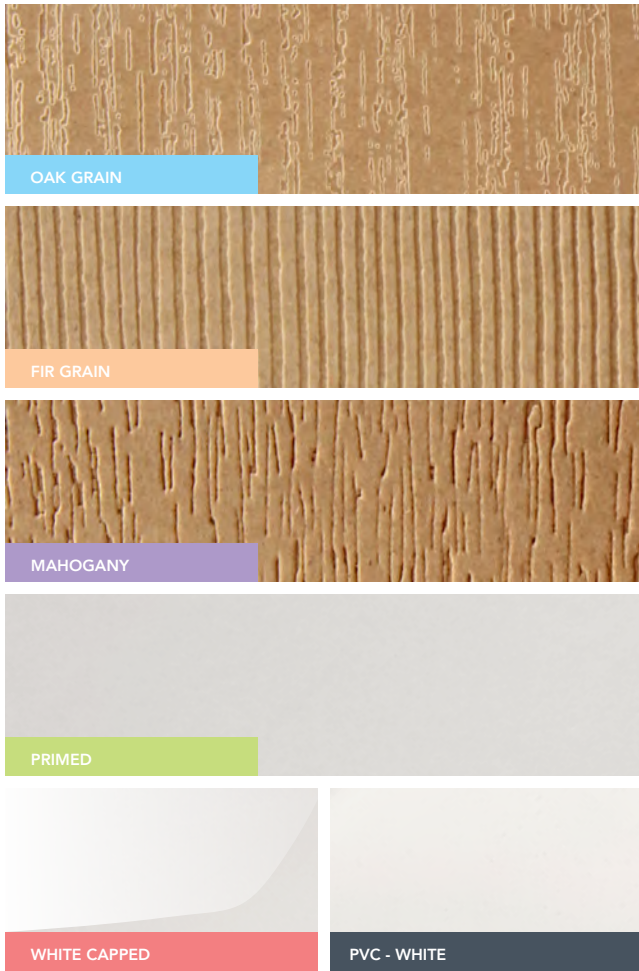

Plastpro Polyfiber (PF) Door Frames are produced with the highest quality and are available in a variety of graining options. For a detailed list of graining available per product, please refer to the chart below.

	OAK GRAIN	FIR GRAIN	MAHOGANY	PRIMED	WHITE CAPPED	PVC - WHITE
4 9/16" DOOR FRAME	●	●	●	●	●	
5 1/4" DOOR FRAME	●			●	●	
6 9/16" DOOR FRAME	●	●	●	●	●	
7 1/4" DOOR FRAME	●			●	●	
WM180 BRICK MOULD	●	●	●	●	●	
WM176 FLORIDA BRICK MOULD	●			●		
1" x 2" STUCCO MOULD				●		
NAILING FIN	●			●	●	
J-CHANNEL	●			●	●	
FLAT CASING	●			●	●	
FLAT CASING J-CHANNEL	●			●	●	
TRIM BOARDS						●
TRANSOM SILLS	●	●	●	●	●	
MULL POSTS	●	●	●	●	●	
MULL POST COVERS (EXTERIOR)	●	●	●	●	●	
MULL POST CAP	●					●
STORM DOOR ADAPTERS	●	●	●	●	●	
DOOR FRAME EXTENSIONS	●	●	●	●	●	
SIDELITE STOPPER	●			●		
ASTRAGAL						●
PFT™ ARCH & RADIUS HEADERS	●					

CHOOSING YOUR DOOR SYSTEM

STEP 1: CHOOSE DOOR TYPE & PANELING



STEP 2: CHOOSE YOUR GLASS



STEP 3: CUSTOMIZE YOUR ENTRY SYSTEM

- CREATE A DOUBLE DOOR ENTRY WAY
- ADD ONE OR TWO MATCHING SIDELITES
- ADD A MATCHING TRANSOM
- ADD DOOR ACCESSORIES
- COMPLETE WITH PF™ DOOR FRAME



STEP 4: CHOOSE FINISH

Plastpro's Stain Kit contains everything you need to stain one prehung door and two sidelites, or one double door unit.

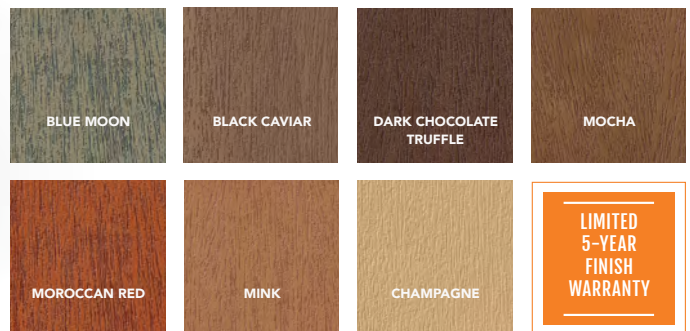

CHOOSE YOUR DOOR DIGITALLY

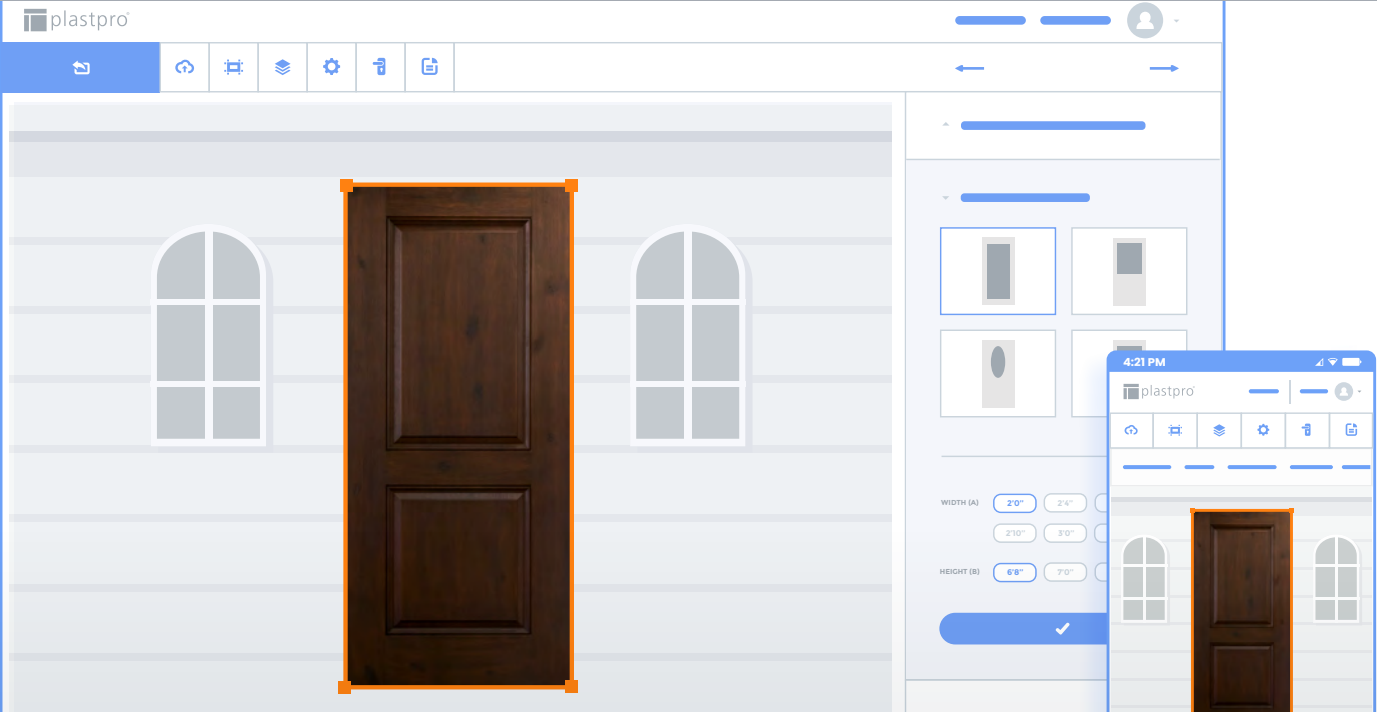

Sometimes it's hard to imagine what a door would look like on your home. A unique home like yours needs a door to complement it perfectly. Our Doorability tool takes the guess work out and lets you see our doors on your home. We have designed a visualizing tool that allows you to upload a photo of your home and instantly add a variety of door and glass options to visual your homes new door.

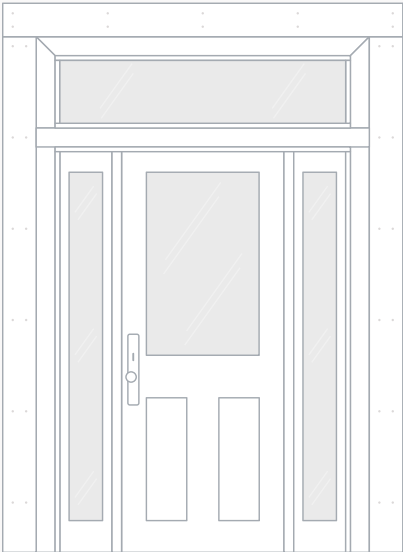

CUSTOMIZE YOUR DREAM ENTRY WAY AT doorability.plastproinc.com

- EASY TO USE
- VISUALIZE THE PERFECT DOOR ON YOUR HOME
- SAVE AND EMAIL YOUR CUSTOM DOOR
- DRAW IN YOUR OPENING FOR AN ACCURATE VISUALIZATION

LIMITED SERIES

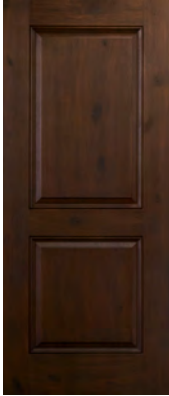

Our Limited Series was specifically selected to showcase some of the richest, luxury graining available.

MODERN SERIES

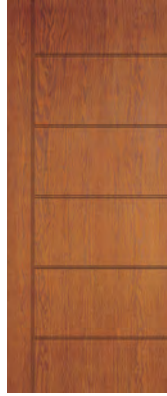

The Modern Series effortlessly makes a contemporary design simpler.

RUSTIC SERIES



Our Rustic Doors were designed to provide classic charm, while bringing traditional, upscale appeal to any home.

MAHOGANY SERIES

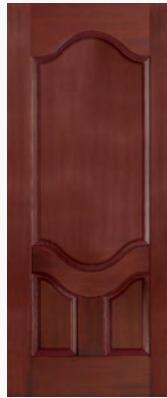

The Mahogany Series brings a beloved wood texture into traditional, timeless styles.

FIR SERIES

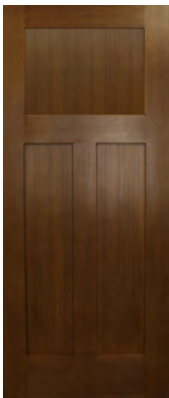

Our Fir Grain Series creates fine details and gives your home a traditional, craftsman appeal.

OAK SERIES



Dressed in a rich oak grain texture, our Oak Grain Series gives a classic look to your home.

SMOOTH SERIES

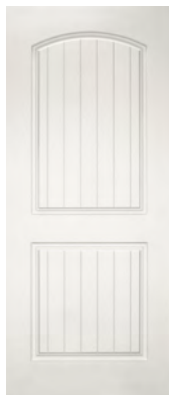

The Smooth Series is made with a pre-pigmented white skin. Its simplicity gives a clean, minimal look to any of our fiberglass doors.

WHITE OAK SERIES



The White Oak Series combines the best features from our Smooth and Oak Grain doors. Any home can enjoy a rich oak texture pattern in a pre-pigmented white skin.

ONELITE SERIES



Our Onelite Series features a fine, flush glazed glass with a removable stop to allow the glass to be switched without changing the entire door.

NOVA SERIES

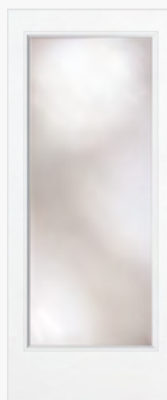

The Nova Series was inspired by the gentle, rising light that causes a calm, peaceful feeling experienced in the early morning.

FIRE RATED



Made with fire-resistant composite, Plastpro Fire Rated doors are extremely durable. Our doors are tested and comply with safety and performance standards to withstand fire for a minimum of 20 minutes. Certain models are available to hold off fire for 60 and 90 minutes. Most importantly, our doors provide a safe home without ever sacrificing style.



= 20min rating option available



= 60min rating option available



= 90min rating option available

Contact us for stock availability.



TRIMMABLE

Our Trimmable Series is designed to fit in a variety of existing entry ways. Adjustments up to 2" in height and width can be made to the door through your contractor. Trimmable doors are available in Oak and Smooth skin. This is the door your home has been waiting for.



= Trimmable Option Available. Contact us for stock availability. (Only available in 3'0" width)



HVHZ IMPACT



Plastpro's High Velocity Hurricane Zone (HVHZ) Impact Doors are engineered to withstand the force of flying objects, while maintaining all the benefits and beauty of our door aesthetic. Our Impact Doors are created, tested, and certified to meet the most stringent wind and impact code requirements in the nation. Our innovative R&D Department has pioneered a unique patent-pending process whereby a missile-proof shield is built-in to reinforce the door.

 = HVHZ Option Available. Contact us for stock availability.

RESIDENTIAL ADA

Our Residential ADA doors are offered in a variety of styles that fulfill all compliances. From Modern to True White Oak, our Residential ADA series has a 10" bottom rail that allows a kick plate to be installed. We have the option to include reinforced blocking through a special order.

 = Residential ADA Option Available. Contact us for stock availability.





DOORLITE OVERVIEW

A beautifully designed entryway helps set the stage for the rest of the home and creates a welcoming passage from public space to private abode. Nothing accomplishes that better than our exclusive glass designs that improve the look and value of your home while adding beauty to your everyday living.

Our doorlites are composed of a piece of decorative glass sealed between two pieces of tempered safety glasses, that provide excellent safety, sound, and thermal performance. The state-of-the-art Warm Edge spacer system provides a seal that protects and insulates your door & home for years to come. Unlike the competition, our metal caming includes a gasket that cushions & protects the glass from chipping, cracking, and rattling during door movement.

DOORLITE

INSULATING SYSTEM

All Plastpro Decorative Doorlites are made with Super Spacer® Cushion Edge™, a flexible, U-shaped, silicone foam tape product used to wrap around and cushion our center decorative panel. Featuring a vapor barrier backing, the product used in combination with Hot Melt butyl, provides a superior Warm-Edge seal.

PERFORMANCE FEATURES

- Warm-Edge Benefits: Superior silicone foam insulation, low thermal conductivity
- Silicon Foam Features: Excellent UV resistance and extreme temperature performance
- Dual-Seal Performance: Chamfered corners for increased sealant depth
- Tempered Safety Glass for your peace of mind



TrueWARM®
spacers
Super Spacer®

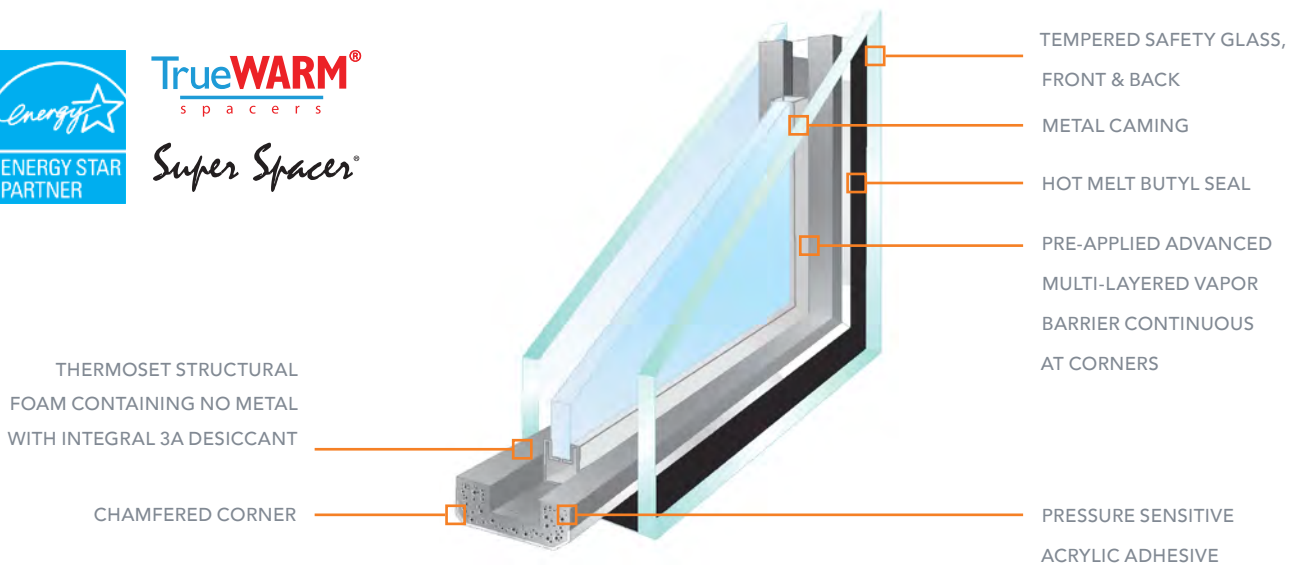

*This illustration applies to our triple pane glass only.

GLASS CAMING OPTIONS

Our exclusive glass designs are offered with different caming options to match a variety of hardware finishes.



WROUGHT IRON

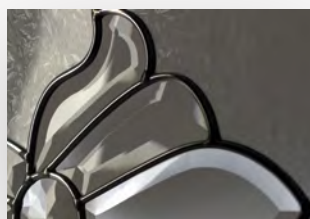

PATINA

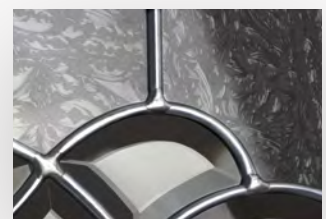

ZINC

CAMELIA

CAMING: WROUGHT IRON
TRANSOM: AVAILABLE



Camelia's wrought iron curves create symmetry, uniformity, and a sense of balance to a door's appearance. Against a waterfall textured background, the design gives the exterior of your home a modern and sophisticated charm, while delivering the ultimate level of privacy.

- 1 Wrought Iron
- 2 Waterfall Tempered Glass



PRIVACY RATING
INCREASING OBSCURITY →



PRISCILLA

CAMING: WROUGHT IRON
TRANSOM: AVAILABLE



Priscilla's smooth swirl design pays tribute to Renaissance style. The wrought iron and little bubble glass gives the design a touch of grandeur, which is perfect for any home looking for an elegant flair.

- 1 Wrought Iron
- 2 Little Bubble Tempered Glass



PRIVACY RATING
INCREASING OBSCURITY →

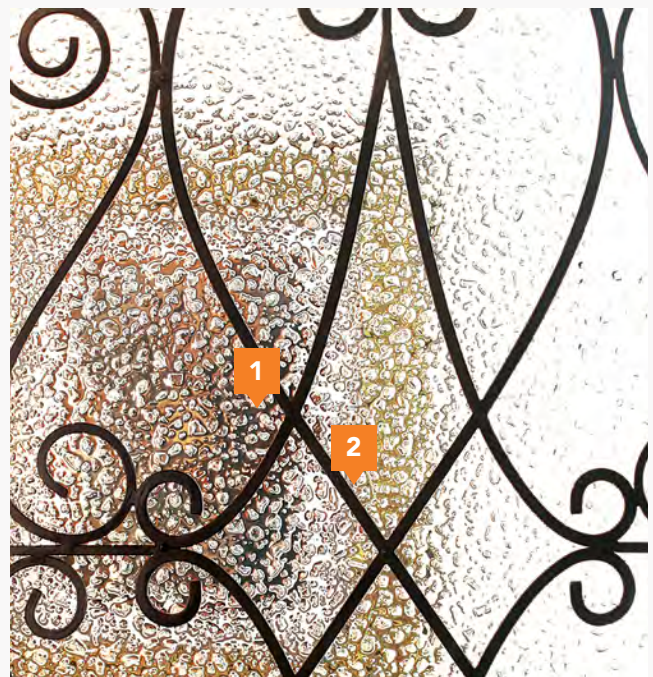

ABERDEEN

CAMING: ZINC
TRANSOM: AVAILABLE



There is more than meets the eye. Although simple in design, Aberdeen gives a modern, clean profile, and its translucent reed glass is perfect for maintaining a high level of privacy to your home.

- 1 Zinc Caming
- 2 Reed Glass



PRIVACY RATING
INCREASING OBSCURITY →

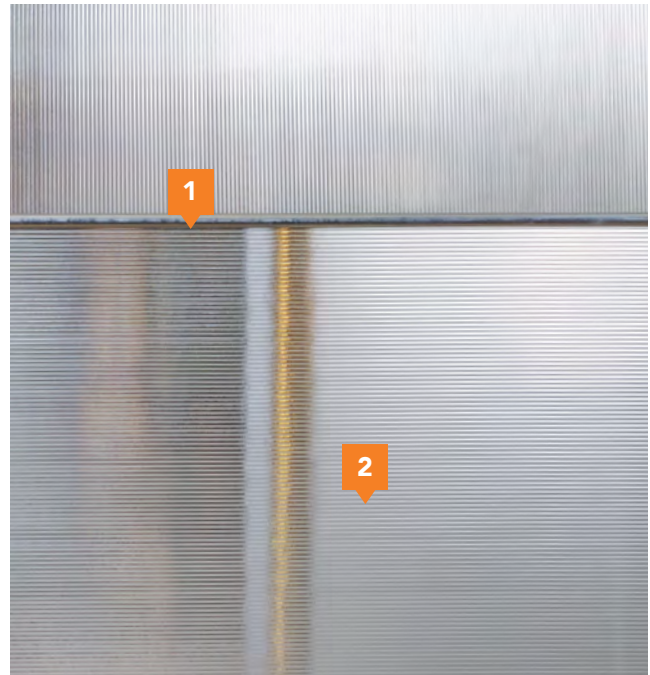

ARTESANO

CAMING: PATINA
TRANSOM: AVAILABLE



Artesano's subtle hint of amber colored glass creates a warm welcoming feeling to any home. This arrangement is the ideal balance between a clear, simple pattern with a combination of glass textures.

- 1 Clear Hammer (100HS)
- 2 Patina Caming
- 3 Amber Glass
- 4 Sea Spray
- 5 Clear Bevel



PRIVACY RATING
INCREASING OBSCURITY →

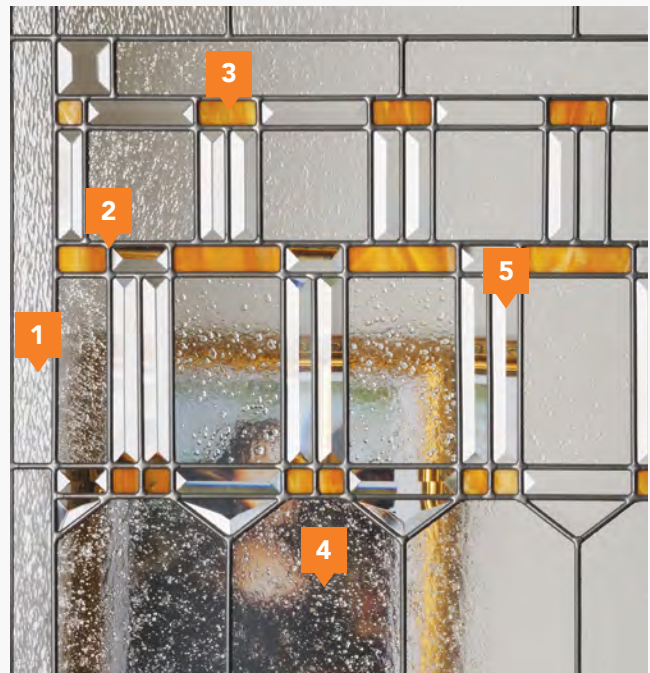

ARTESANO BREEZE

CAMING: ZINC
TRANSOM: AVAILABLE



Artesano's classic design is a tasteful blend of small and large geometric shapes. This pattern's transparent features work to create a sophisticated, decorative, and elegant look to any entry door.

- 1 Clear Hammer (100HS)
- 2 Zinc Caming
- 3 Clear Bevel
- 4 Sea Spray

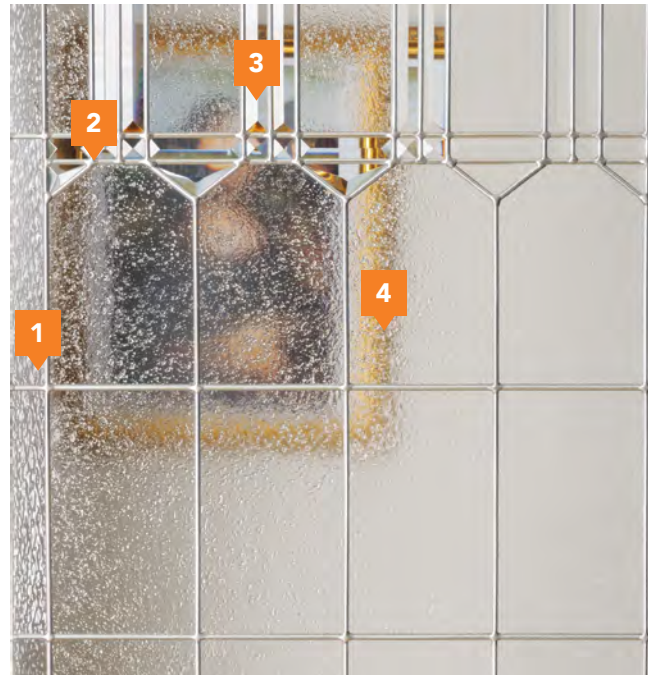

BRENTWOOD

CAMING: ZINC OR PATINA
TRANSOM: AVAILABLE



A classic inspired arrangement, our Brentwood piece epitomizes style. With bevel swirls and a bold centerpiece all outlined by a crystal granite border, Brentwood can be appreciated in any home.

- 1 Baroque
- 2 Clear Bevel
- 3 Bright Zinc, or Patina Caming
- 4 Granite



CASTILE

CAMING: PATINA
TRANSOM: AVAILABLE



Inspired by the historical Spanish kingdom, Castile is as ornate as its nature and history. The baroque style glass balances the intricacy of its centerpiece with a straight-lined, beveled border. Castile is the epitome of modern design.

- 1 Granite
- 2 Baroque
- 3 Patina Caming
- 4 Beveled



PRIVACY RATING
INCREASING OBSCURITY

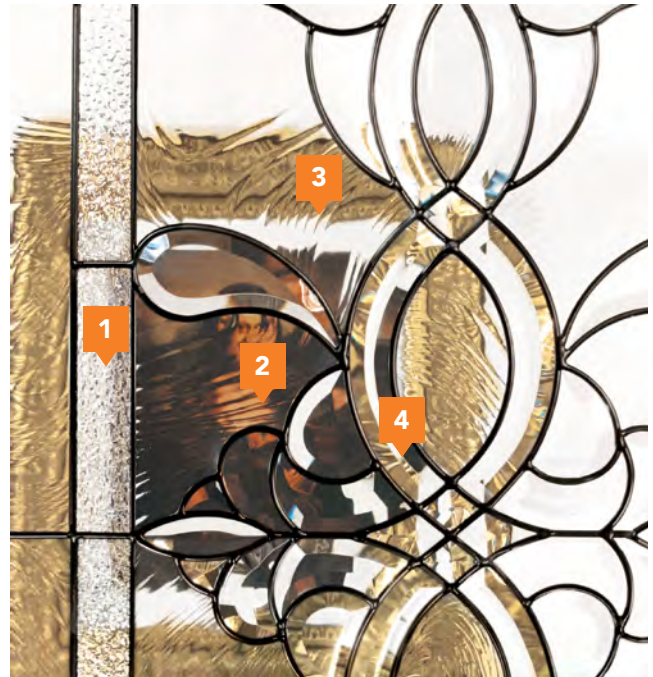

KENSINGTON

CAMING: PATINA
TRANSOM: AVAILABLE



Kensington brings a classic English atmosphere to anyone's curb appeal. A combination of frosted glass and subtle line patterns gives a high level of charm to this distinct beauty.

- 1 100 Water
- 2 Clear Bevel
- 3 Narrow Reed
- 4 Sandblasted Glass
- 5 Patina Caming



PRIVACY RATING
INCREASING OBSCURITY

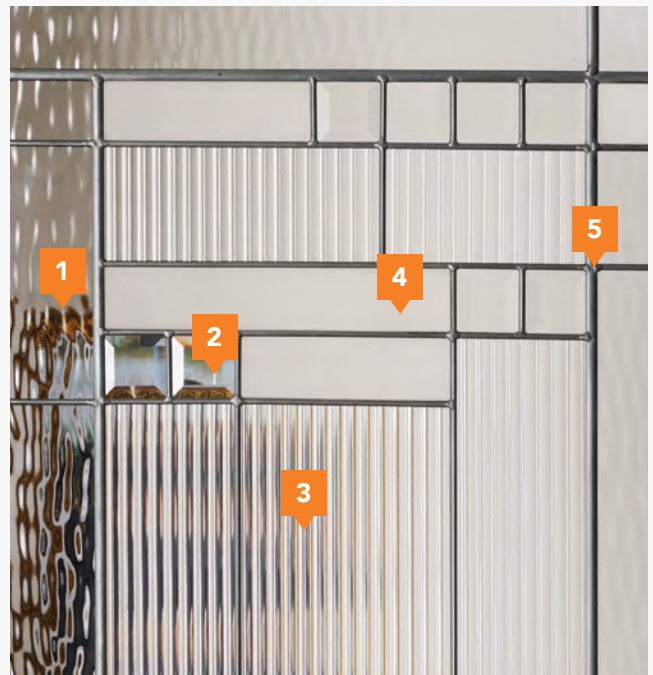

SPRING

CAMING: PATINA
TRANSOM: AVAILABLE



This chevron pattern arrangement emphasizes clean-cut arrows with two toned glass colors. It provides a subtle charm to its otherwise simple pattern. The pale gray, water-like glass texture gives a sense of energy and renewal reminiscent of spring.

- 1 Light Water
- 2 Clear Chord
- 3 Pale Gray Water
- 4 Patina Caming



PRIVACY RATING
INCREASING OBSCURITY →

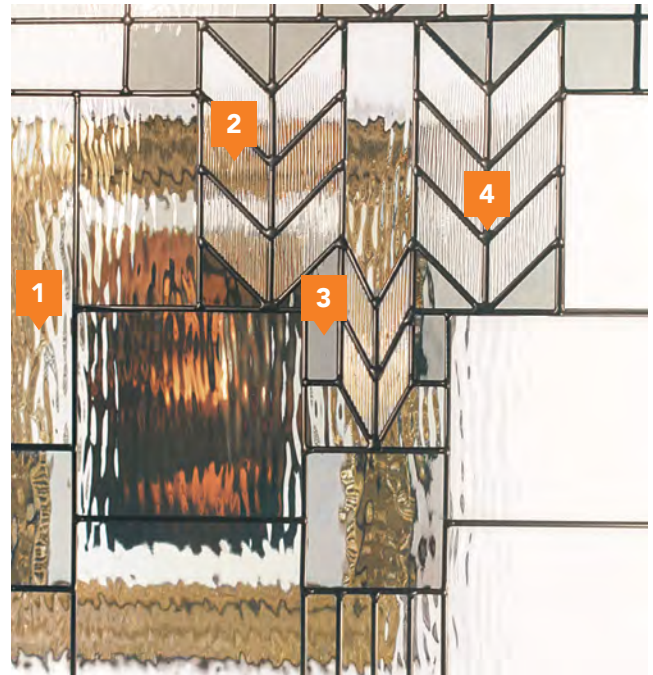

TABITHA

CAMING: PATINA
TRANSOM: AVAILABLE



A clustered flower atop Tabitha is the perfect accent to this romantic centerpiece. The mix of patterns and textures give the arrangement a fluid, contemporary design that will always be admired.

- 1 Granite
- 2 Double Water
- 3 Clear Bevel
- 4 Patina Caming



PRIVACY RATING
INCREASING OBSCURITY →

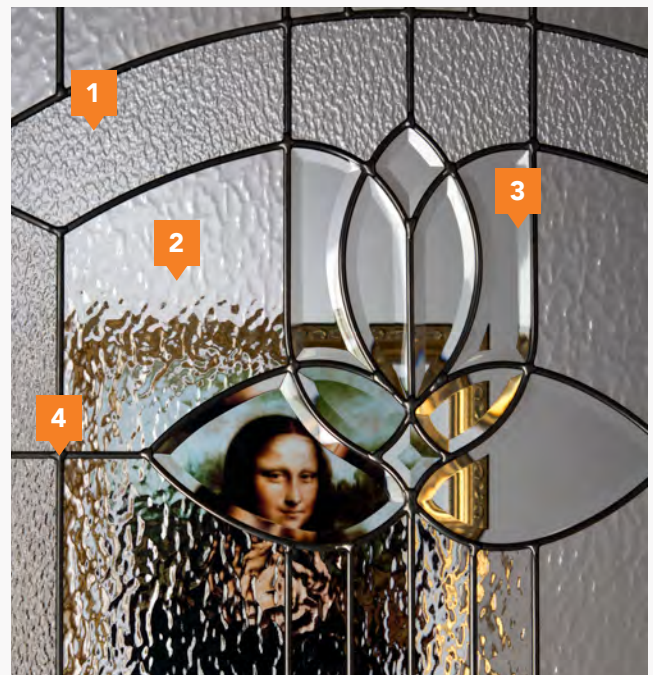

USE GLASS IMAGE



Oak Series • DRG80 • Glass CAM8C2

SOLUTION DOORLITE SERIES



Clean lines, a straightforward design, these are the features that make Shaker doors timeless. A door that adds effortless style to any home needs a frame and glass to complement its unique features. The Solution series doorlites feature a low-profile, flat frame and patterned glass that was created to complement the clean, simple designs of our Shaker and flush doors.

The Solution Doorlite Series is available in various sizes, which makes it easy to create and customize an infinite number of contemporary looks. The screwless design eliminates holes and plugs and saves valuable time in installation as a traditional screw frame requires extra time to install screws and plugs. The frame features a patented interlocking joint and compression seal that adheres to the door and creates a powerful compression seal and bond. It safely locks decorative glass in place, while beautifully illuminating and bringing out the features of the glass. Its versatility matches many styles, such as Modern, Craftsman, Mid-Century, and so many more. There are no screw holes, is built to resist warping, and is available in a textured vertical grain pattern in both white and tan.

FEATURES & BENEFITS

- No unsightly plugs or screw holes.
- Available in white or tan.
- Textured vertical grain pattern.
- Matches various architectural styles.
- Shaker style low profile.
- Patented frame system.
- Built to resist warping.
- Easy Installation saving labor cost.

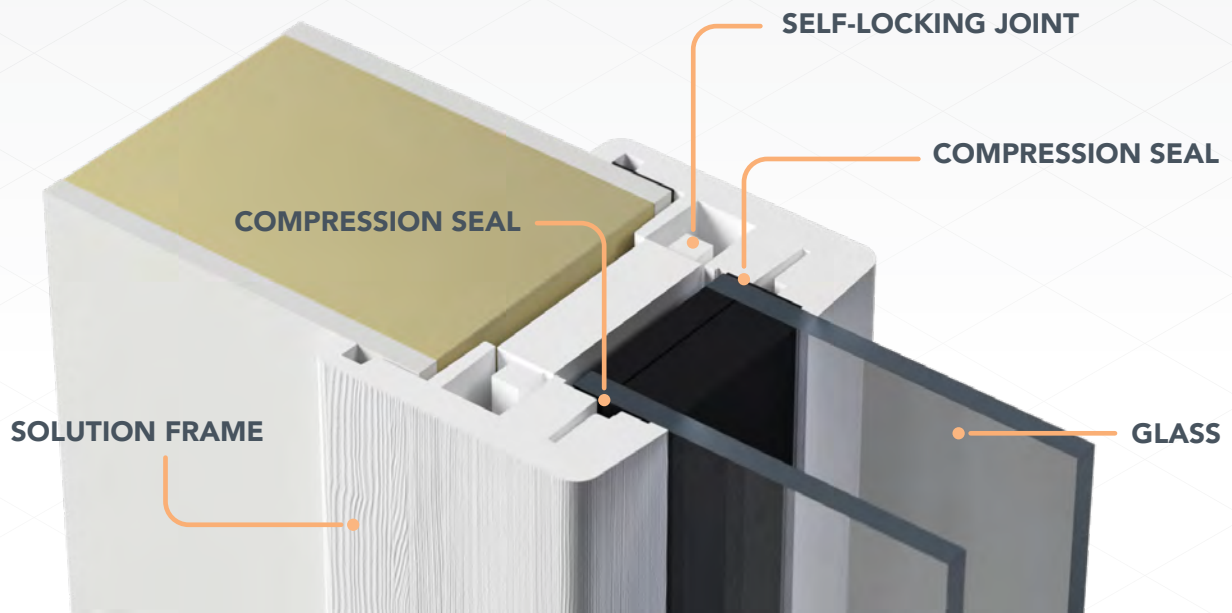

FRAME AND GLASS SELECTIONS

TEXTURE GLASS OPTIONS



CLEAR / LoE

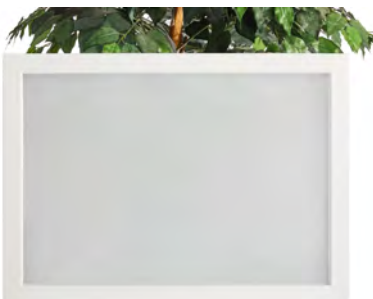

WHITE LAMINATE



SANDBLAST



SABLE



ROOFTOP



NARROW REED

FRAME OPTIONS



7" x 64" *

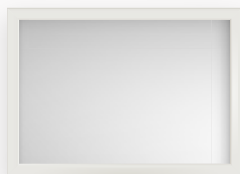

22" x 15" *

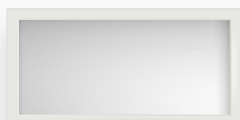

22" x 10"



22" x 8"



22" x 3"



8" x 36" *



22" x 36" *

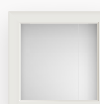

8" x 8"

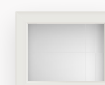

8" x 6"

* AVAILABLE WITH DECORATIVE GLASS OPTIONS.

FRAME CONFIGURATION EXAMPLES

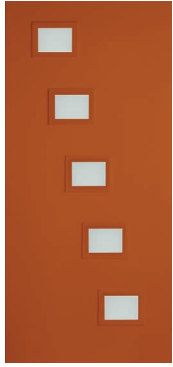

STAGGERED 5 LITE
8" x 6"



SIDE ALIGNED 6 LITE
8" x 6"



DIAMOND 4 LITE
8" x 8"



STAGGERED 4 LITE
8" x 8"



CENTERED 4 LITE
8" x 8"

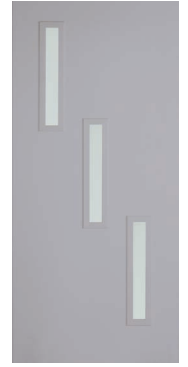

STAGGERED 3 LITE
3" x 22"



MODERN 4 LITE
22" x 3"



MODERN 6 LITE
22" x 3"



FOUR LITE
22" x 8"



FIVE LITE
22" x 8"



SIX LITE
22" x 8"



FOUR LITE
22" x 10"



THREE LITE
22" x 15"



**DIVIDED 6 LITE W/
4 LITE BOTTOM**
22" x 15" & 22" x 3"



**SINGLE TOP LITE W/
4 LITE BOTTOM**
22" x 15" & 22" x 3"

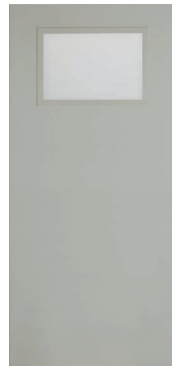

SINGLE TOP LITE
22" x 15"



SINGLE LITE
7" x 64"

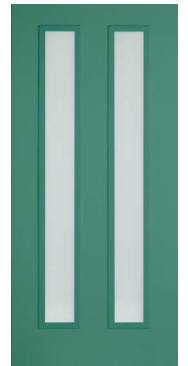

TWIN FULL LITE
7" x 64"

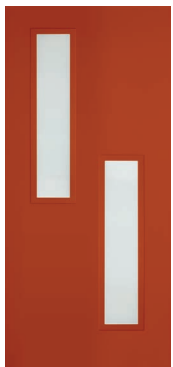

STAGGERED TWIN LITE
8" x 36"

DOOR COLORS ARE FOR VISUALIZATION PURPOSES ONLY. CHECK WITH YOUR LOCAL DEALER FOR AVAILABILITY



Smooth Series • DRS0080 • 22" x 8" Solution Frame w/ Translucent Glass

LIMITED SERIES



Limited Series • Knotty Alder Door • DRK2B



Limited Series • Cherry Door • DRC21

Our Limited Series was specifically selected to showcase some of the richest, luxury graining available. The Cherry, Knotty Alder, and Teak doors are fine, subtle, but detailed. Cherry is a premium American hardwood, prized for its natural luster and attractive grain. Knotty Alder is admired for its subtle swirls and rich grain pattern with sound knots. Teak is a worldwide favorite for its beautiful straight, yet occasionally wavy or interlocked grain patterns. These grains exude an authentic wood grain and are so versatile they will complement any home.

ALL LIMITED DOORS ARE SHOWN PRE-FINISHED

DOOR OVERVIEW

6'8"



3'0"

DRC21
Cherry



6'8"

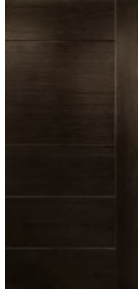

2'8" • 2'10" • 3'0" • 3'6"

DMT51
Teak

7'0"

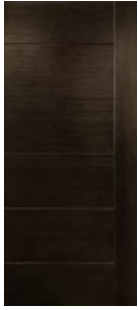

3'0" • 3'6"

DMT5170
Teak

6'8"



2'8" • 2'10" • 3'0"

DRK2B
Knotty Alder

10" BOTTOM RAIL IN STOCK EXTENDED LEAD TIME



Limited Series • Knotty Alder Door • DRK2B

CHERRY TWO PANEL DOOR

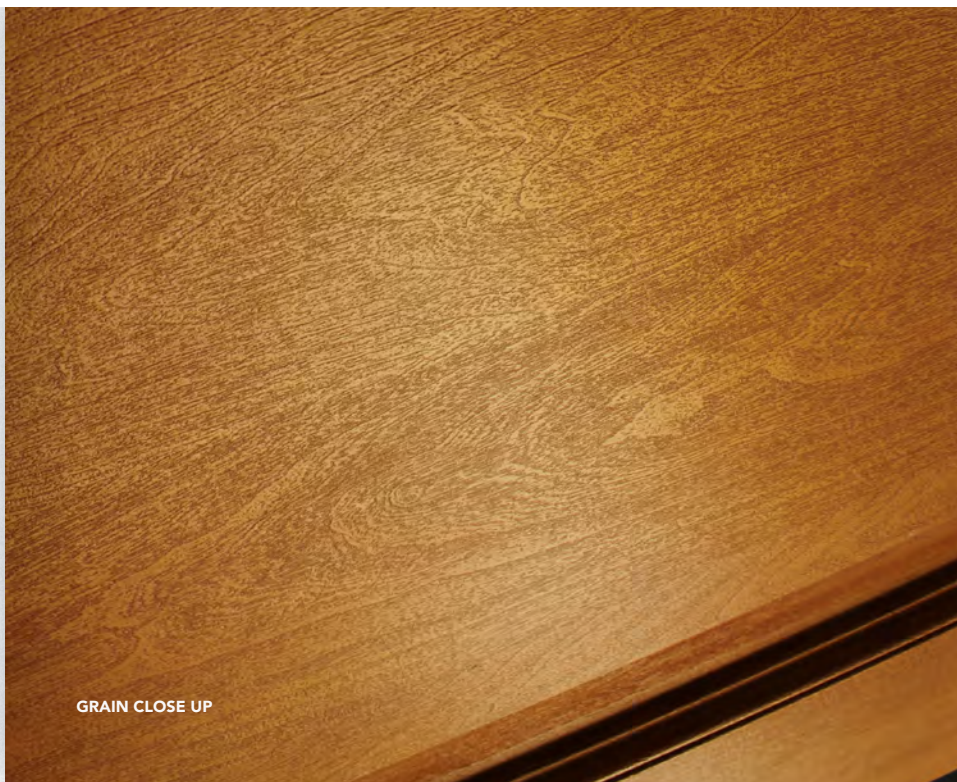

GLASS OPTIONS

6'8"



CAMFL7

6'8"



PCLFL7

6'8"



ABRFL7Z

6'8"



ARTFL7P

6'8"



ARZFL7Z

6'8"



BREFL7P/Z

6'8"



CASFL7P

6'8"



KENFL7P

6'8"



OXFFL7

6'8"



SOLFL7P

6'8"



SPRFL7P

6'8"

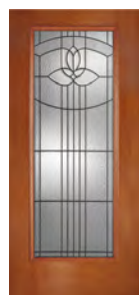

TABFL7P

TWO PANEL DOOR

6'8"



CAMFL1

6'8"



PCLFL1

6'8"



ABRFL1Z

6'8"



ARTFL1P

6'8"



ARZFL1Z

6'8"



BREFL1P/Z

6'8"



CASFL1P

6'8"



KENFL1P

6'8"



OXFFL1

6'8"



SOLFL1P

6'8"

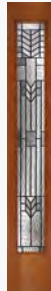

SPRFL1P

6'8"

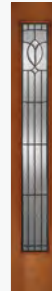

TABFL1P



MODERN TEAK MILAN DOOR

6'8"

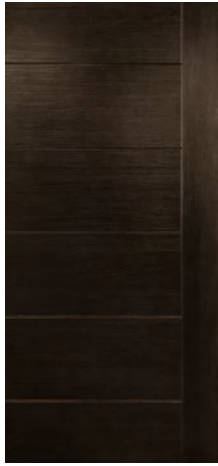

2'8" • 2'10" • 3'0" • 3'6"

DMT51

● IN STOCK

7'0"

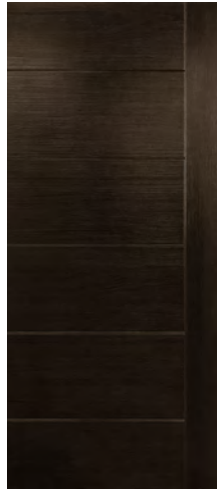

3'0" • 3'6"

DMT5170

● EXTENDED LEAD TIME



GRAIN CLOSE UP

SQUARE TOP

KNOTTY ALDER TWO PANEL DOOR

6'8"



28" • 2'10" • 30"

DRK2B

● IN STOCK ● EXTENDED LEAD TIME

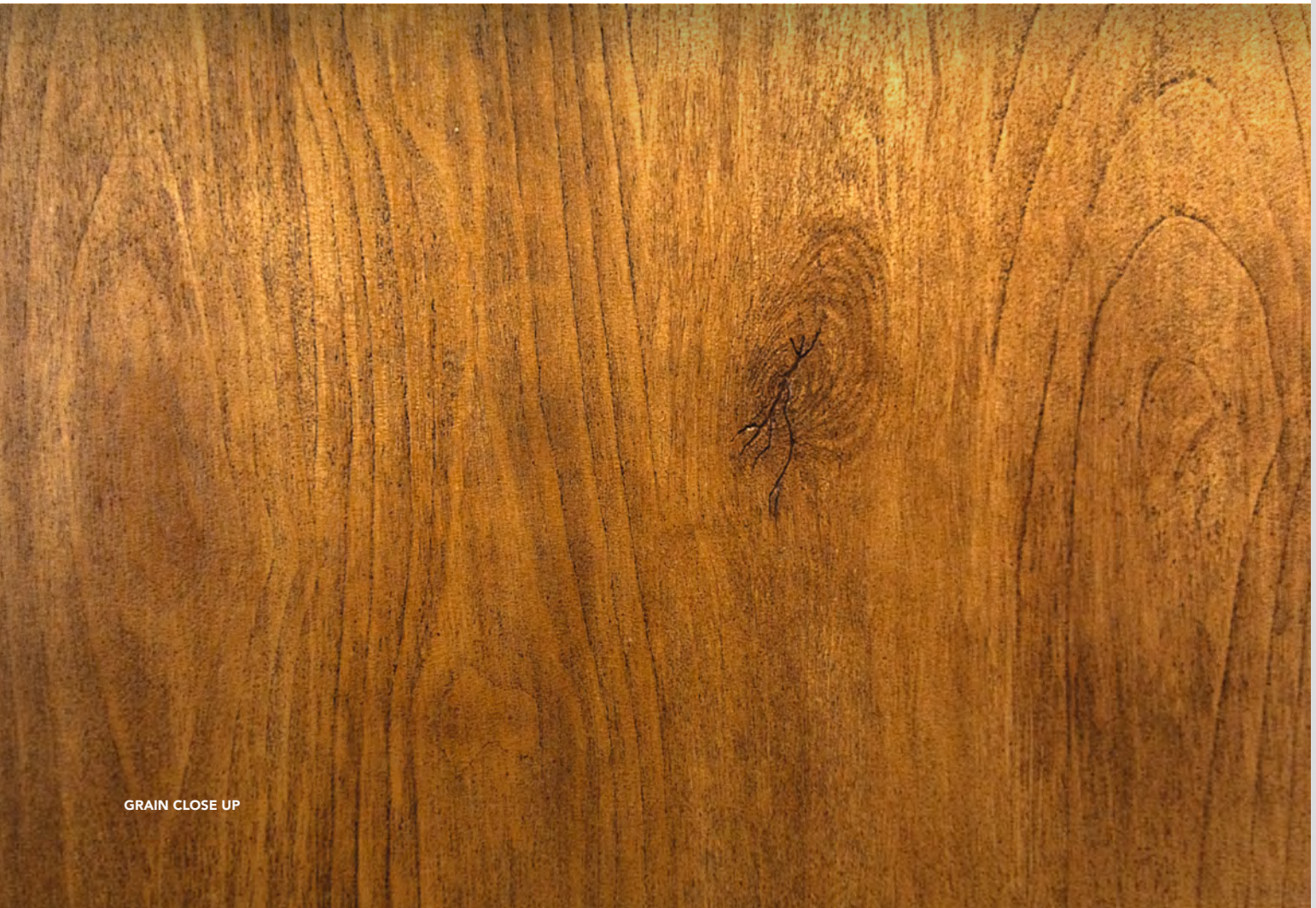

GRAIN CLOSE UP



MODERN SERIES















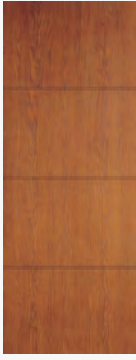



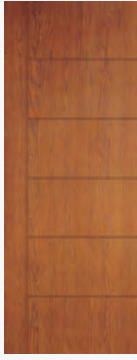











Modern Series • Oak Door • DMG46



The Modern Series effortlessly makes a contemporary design simpler. Our doors are designed to have a cleaner style by incorporating clean, simple lines and single patterned glass. This clean look can complement any homes interior and exterior.

ALL MODERN DOORS ARE SHOWN PRE-FINISHED

DOOR OVERVIEW

<p>6'8"</p>  <p>2'6" • 2'8" • 2'10" • 3'0" • 3'6"</p> <p>DMG46</p>  	<p>8'0"</p>  <p>2'6" • 2'8" • 2'10" • 3'0" • 3'6"</p> <p>DMG4680</p>  	<p>6'8"</p>  <p>2'6" • 2'8" • 2'10" • 3'0" • 3'6"</p> <p>DMG51</p> 	<p>8'0"</p>  <p>2'6" • 2'8" • 2'10" • 3'0" • 3'6"</p> <p>DMG5180</p> 		
<p>6'8"</p>  <p>2'6" • 2'8" • 2'10" • 3'0" • 3'6"</p> <p>DMS1L</p> 	<p>8'0"</p>  <p>3'0" • 3'6"</p> <p>DMS1L80</p> 	<p>6'8"</p>  <p>2'6" • 2'8" • 2'10" • 3'0" • 3'6"</p> <p>DMS1R</p> 	<p>8'0"</p>  <p>3'0" • 3'6"</p> <p>DMS1R80</p> 	<p>6'8"</p>  <p>2'6" • 2'8" • 2'10" • 3'0" • 3'6"</p> <p>DMS1T</p> 	<p>8'0"</p>  <p>3'0" • 3'6"</p> <p>DMS1T80</p> 
<p>6'8"</p>  <p>2'6" • 2'8" • 2'10" • 3'0"</p> <p>DMS3H</p> 	<p>8'0"</p>  <p>2'6" • 2'8" • 2'10" • 3'0"</p> <p>DMS3H80</p> 	<p>6'8"</p>  <p>2'6" • 2'8" • 2'10" • 3'0"</p> <p>DMS5H</p> 	<p>8'0"</p>  <p>2'6" • 2'8" • 2'10" • 3'0"</p> <p>DMS5H80</p> 		

OAK GRAIN SKIN

SMOOTH SKIN

SMOOTH SKIN

MODERN SERIES

MODERN OAK SOUTH BEACH DOOR

6'8"

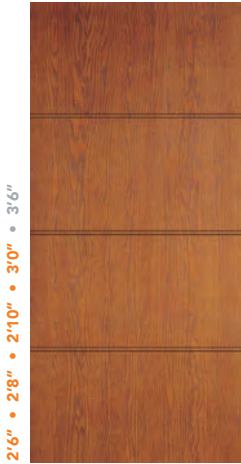

2'6" • 2'8" • 2'10" • 3'0" • 3'6"

DMG46

8'0"

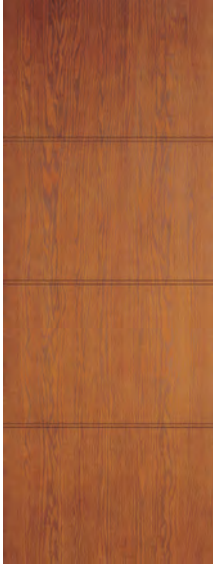

2'6" • 2'8" • 2'10" • 3'0" • 3'6"

DMG4680

MODERN OAK NAPOLI DOOR

6'8"

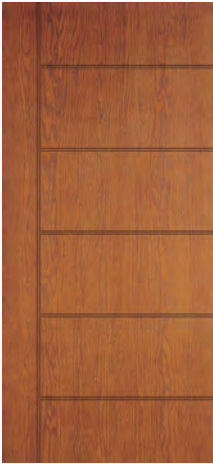

2'6" • 2'8" • 2'10" • 3'0"

DMG51

8'0"

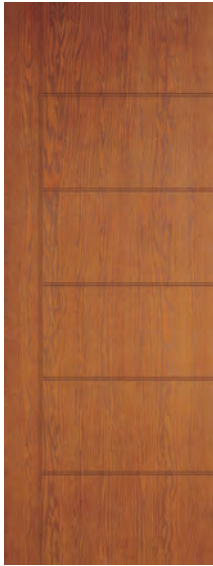

2'6" • 2'8" • 2'10" • 3'0"

DMG5180

MODERN SMOOTH BIENVENUE DOOR

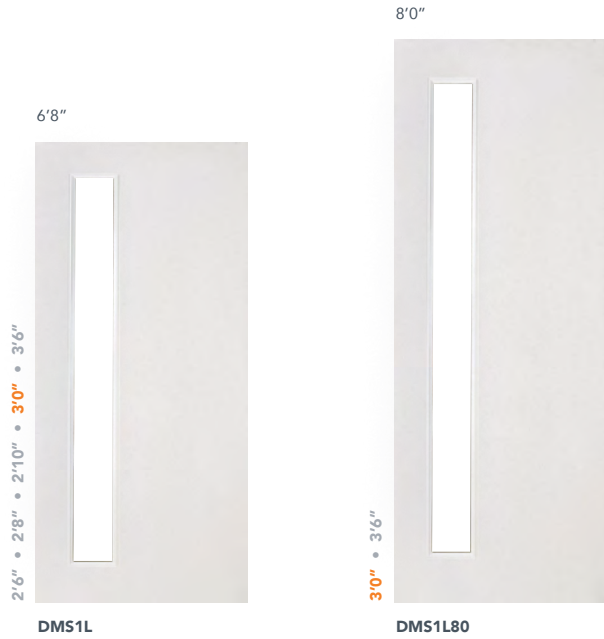

GLASS OPTIONS



MODERN GLASS CLOSE UP

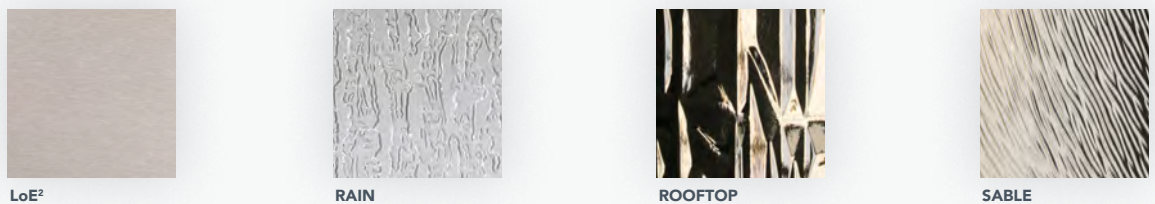

MODERN SMOOTH BIENVENUE DOOR

FLUSH GLAZED SINGLE RIGHT LITE



GLASS OPTIONS



MODERN GLASS CLOSE UP

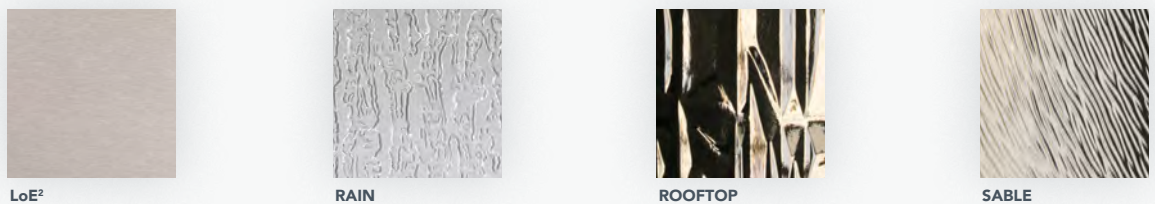

MODERN SMOOTH MARTINIQUE DOOR

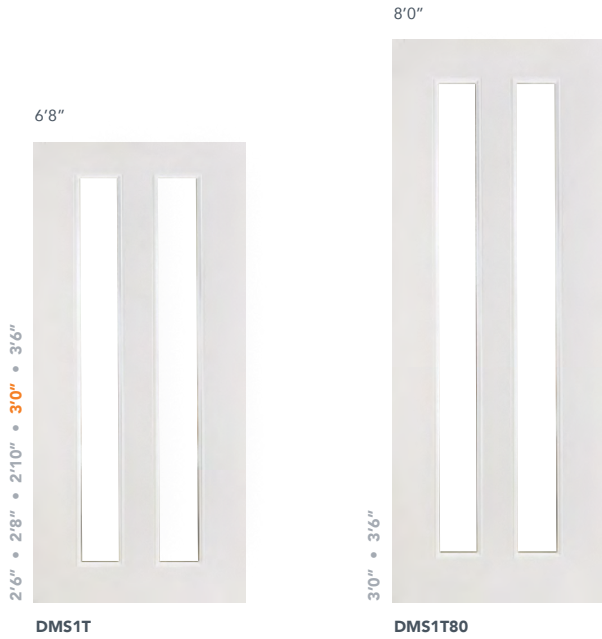

GLASS OPTIONS

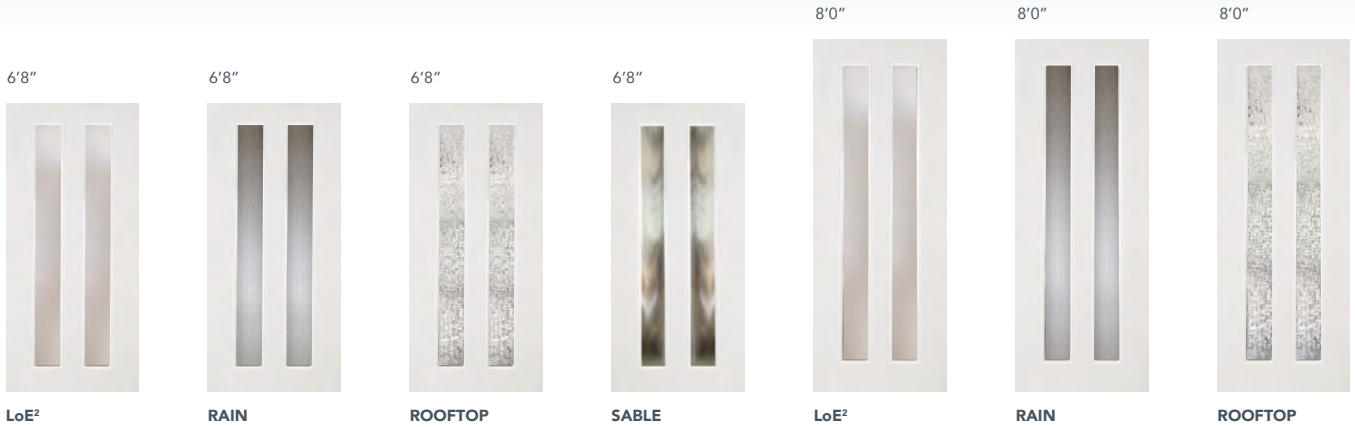

MODERN GLASS CLOSE UP

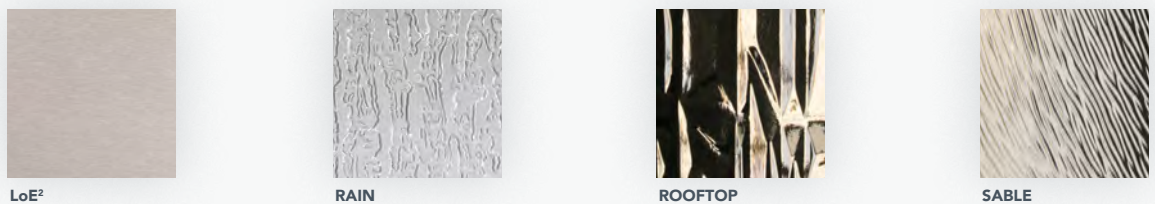

MODERN SMOOTH EMPIRE DOOR



MODERN SMOOTH INFINITY DOOR





Modern Series • Oak Door • DMG46

RUSTIC SERIES



Rustic Series • DRA2D

Our line of Rustic Doors were designed to provide classic charm, while bringing traditional, upscale appeal to any home. Doors in the Rustic Series display vertical planks, distinct panel details, and arched and radius tops. The Rustic Series only uses wrought iron glass and rustic accessories to reinforce that mid-century rustic look.

ALL RUSTIC DOORS ARE SHOWN PRE-FINISHED

DOOR OVERVIEW

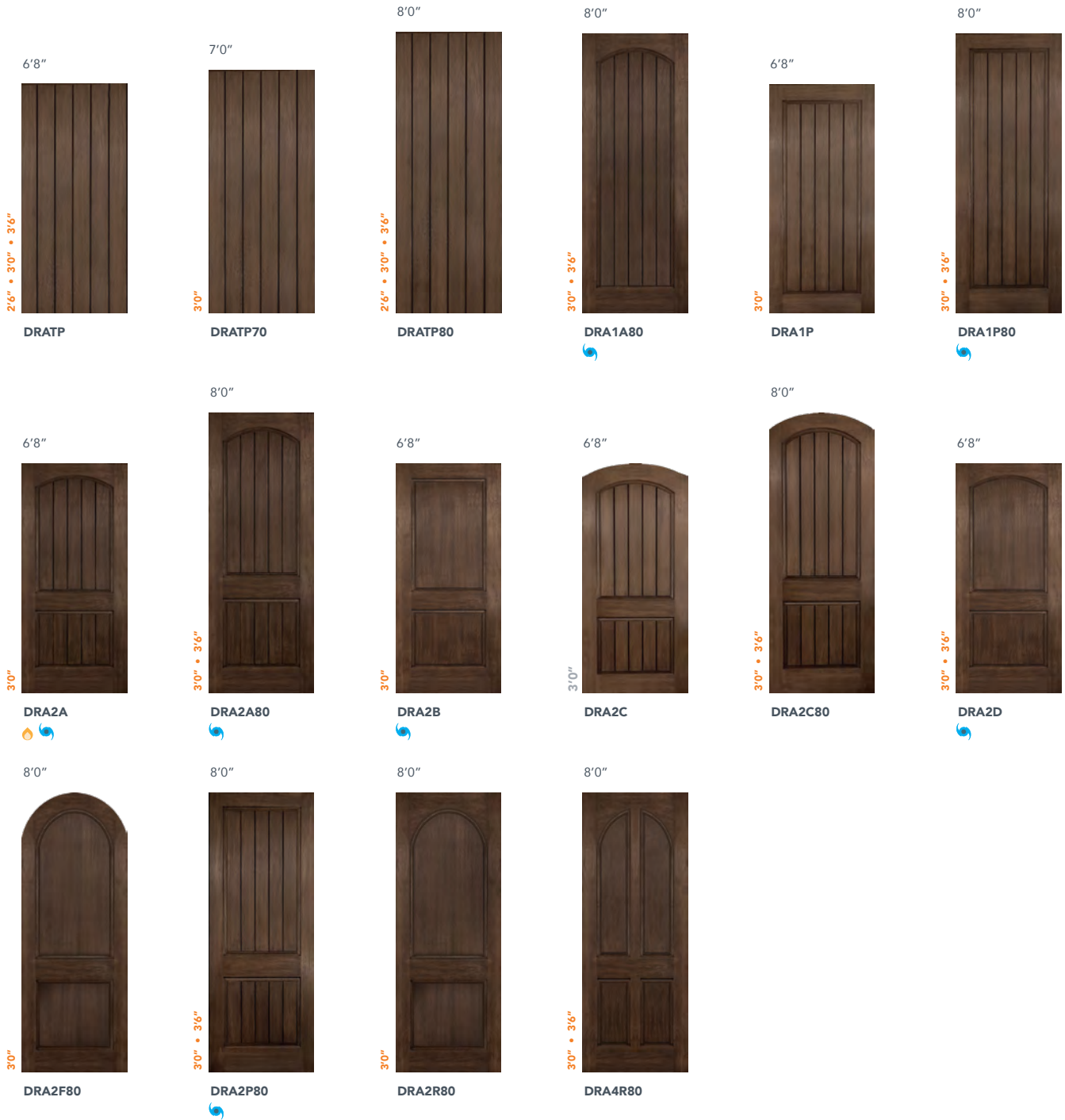

RUSTIC TRUE PLANK DOOR

SQUARE TOP

6'8"



2'6" • 3'0" • 3'6"

DRATP

7'0"



3'0"

DRATP70

8'0"



2'6" • 3'0" • 3'6"

DRATP80

RUSTIC ONE PANEL DOOR

ARCH PLANK & SQUARE TOP

8'0"



3'0" • 3'6"

DRA1A80

RUSTIC ONE PANEL DOOR

6'8"



3'0"

DRA1P

8'0"



3'0" • 3'6"

DRA1P80

● IN STOCK

● EXTENDED LEAD TIME



Rustic Series • DRA1P

RUSTIC TWO PANEL DOOR

ARCH PLANK & SQUARE TOP



GLASS OPTIONS

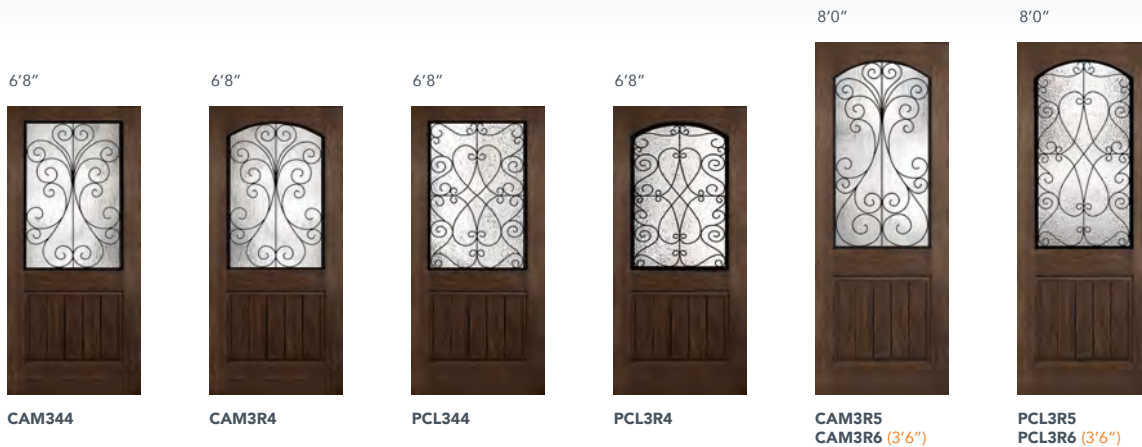

RUSTIC TWO PANEL DOOR



GLASS OPTIONS

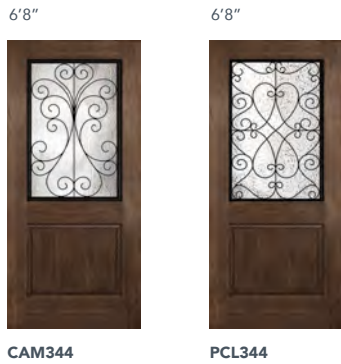

RUSTIC TWO PANEL DOOR

ARCH PLANK & ARCH TOP



GLASS OPTIONS

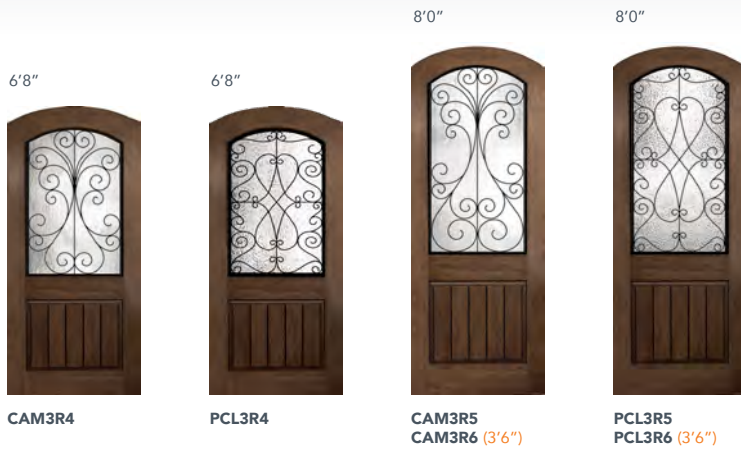

6'8"



3'0" • 3'6"

DRA2D

GLASS OPTIONS

6'8"



CAM3R4

6'8"



PCL3R4

6'8"

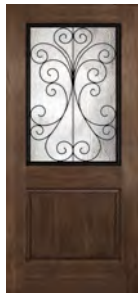

CAM344

6'8"



PCL344

RUSTIC TRUE PLANK DOOR

RADIUS PANEL & RADIUS TOP

8'0"



3'0"

DRA2F80

RUSTIC TWO PANEL DOOR

SQUARE PLANK & SQUARE TOP

8'0"



3'0" • 3'6"

DRA2P80

8'0"



CAMHL6
CAM346 (3'6")

8'0"



PCLHL6
PCL346 (3'6")

RADIUS PANEL & SQUARE TOP

RUSTIC TWO PANEL DOOR

8'0"



3'0"

DRA2R80

RADIUS PANEL & SQUARE TOP

RUSTIC FOUR PANEL DOOR

8'0"



3'0" • 3'6"

DRA4R80

● IN STOCK

● EXTENDED LEAD TIME



RUSTIC SERIES ACCESSORIES

1.5" Square



ACCLP12Q

1.25" Square



ACCLP14Q

1.5" Round



ACCLP12R

1.25" Round



ACCLP14R

DECORATIVE CLAVOS

Plastpro Decorative Clavos provide the perfect accent to some of the most beautiful and highest quality fiberglass doors in the industry. In addition to providing a distinct and unique element to any fiberglass distressed door, our Decorative Clavos enhance our fiberglass entry doors, and provide the perfect "finishing touch" to virtually every Rustic Door we provide.

FEATURES & BENEFITS

- Easy to Apply
- Scientifically Formatted Adhesive Unique for Fiberglass Doors
- Masterfully Crafted Premium Metal Alloy
- Tough and Durable Powder Coat Finish

6'8"



DRA1P
ACCLP14Q

8'0"



DRA1P80
ACCLP14Q

6'8"



DRA2C
ACCLP14R

8'0"



DRA2C80
ACCLP14R

8'0"



DRA1A80
ACCLP12Q

● IN STOCK ● EXTENDED LEAD TIME

ACCESSORIES ARE APPLIED BY PLASTPRO DISTRIBUTORS / DEALERS

Speakeasy



ACCSPKY0910KIT

Speakeasy



ACCSPKYGSB0KIT

SPEAKEASY & HINGE STRAP

Plastpro has extended its line of authentic door accessories with the addition of the Hinge Strap and a Speakeasy Kit. Our Hinge Straps and Speakeasy Kit are handcrafted from durable aluminum that resists rust and discoloration. The Speakeasy Kit comes with a distinctive rounded iron grill that enhances the old world styling of our Rustic Door Collection and helps to create a personalized look for your new entry way.

18" Hinge Straps



ACCHGSP18

FEATURES & BENEFITS

- Durable Powder Coat Finish
- Combats Rust and Discoloration
- Beautifully Textured
- Masterfully Handcrafted

View In
6'8"



DRA2D
ACCSPKY0910KIT

View Out
8'0"



DRA2R80
ACCHGSP18
ACCSPKY0910KIT

View In
6'8"



DRA2D
ACCSPKYGSB0KIT

View Out
8'0"



DRA2R80
ACCHGSP18
ACCSPKYGSB0KIT

MAHOGANY SERIES



Mahogany Series • DRM4E



The Mahogany Series brings a beloved wood texture into traditional, timeless styles. Our doors come with classic panel designs that can carry all of our decorative glass designs. This series radiates beauty, elegance, and strength to your home.

ALL MAHOGANY DOORS ARE SHOWN PRE-FINISHED

DOOR OVERVIEW



● IN STOCK ● EXTENDED LEAD TIME



Mahogany Series • DRM60

MAHOGANY THREE PANEL DELUXE DOOR

6'8"



3'0"

1'0" • 1'2"

DRM3D

SLM3D

GLASS OPTIONS

6'8"



BRE3V2P/Z

6'8"

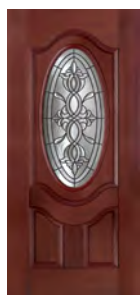

CAS3V2P

6'8"

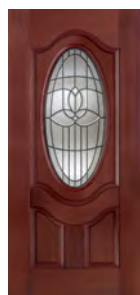

TAB3V2P

6'8"

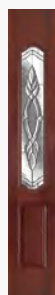

BRE3V1P/Z

6'8"



CAS3V1P

6'8"

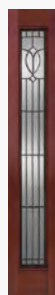

TABFL1P

MAHOGANY FOUR PANEL EYEBROW DOOR

6'8"



DRM4E

SLM60

GLASS OPTIONS

6'8"



BREEYEP/Z

6'8"

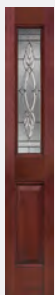

BREHL2P/Z

6'8"



BREFL1P/Z

● IN STOCK

● EXTENDED LEAD TIME

MAHOGANY FOUR PANEL BLANK TOP DOOR

6'8"



DRM40

SLM60

GLASS OPTIONS

6'8"

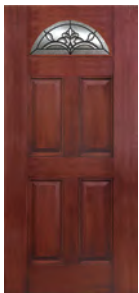

CASHR1P

6'8"



TABHR1P

6'8"

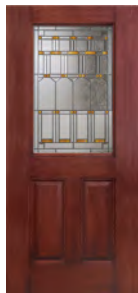

ARHL4P
ARHL3P (2'6")

6'8"



ARZHL4Z
ARZHL3Z (2'6")

6'8"



BREHL4P/Z

6'8"

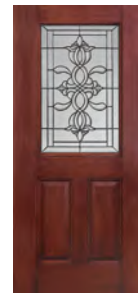

CASHL4P
CASHL3P (2'6")

6'8"

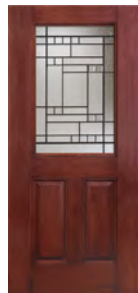

KENHL4P
KENHL3P (2'6")

6'8"



OXFHL4

6'8"



SOLHL4P
SOLHL3P (2'6")

6'8"

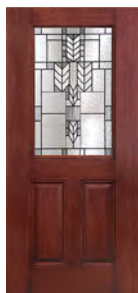

SPRHL4P

6'8"

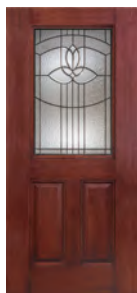

TABHL4P
TABHL3P (2'6")

6'8"

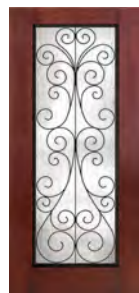

CAMFL7
CAMFL5 (2'6")

6'8"



PCLFL7
PCLFL5 (2'6")

6'8"



ABRFL7Z
ABRFL5Z (2'6")

FOUR PANEL BLANK TOP DOOR

6'8"

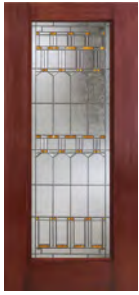

ARTFL7P
ARTFL5P (2'6")

6'8"



ARZFL7Z
ARZFL5Z (2'6")

6'8"



BREFL7P/Z

6'8"

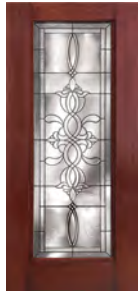

CASFL7P
CASFL5P (2'6")

6'8"



KENFL7P
KENFL5P (2'6")

6'8"



OXFLL7

6'8"



SOLFL7P
SOLFL5P (2'6")

6'8"



SPRFL7P

6'8"



TABFL7P
TABFL5P (2'6")

6'8"



ARTHL2P

6'8"



ARZHL2Z

6'8"

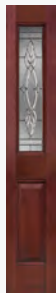

BREHL2P/Z

6'8"



CASHL2P

6'8"

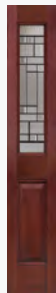

KENHL2P

6'8"

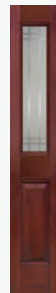

OXFHL2

6'8"

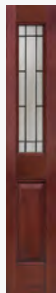

SOLHL2P

6'8"



SPRHL2P

6'8"



CAMFL1

6'8"



PCLFL1

6'8"



ABRFL1Z

6'8"



ARTFL1P

6'8"



ARZFL1Z

6'8"



BREFL1P/Z

FOUR PANEL BLANK TOP DOOR

6'8"



CASFL1

6'8"



KENFL1P

6'8"



OXFFL1

6'8"



SOLFL1P

6'8"

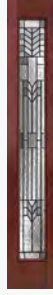

SPRFL1P

6'8"

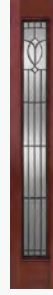

TABFL1P

MAHOGANY TRUE FOUR PLANK DOOR

6'8"



DRM41

3'6"

MAHOGANY SIX PANEL DOOR



GLASS OPTIONS



FIR SERIES



Fir Series • DRF3C • Glass G000 • SDL ACSDF23006 • Dentil Shelf ACDSFT2704



Our Fir Series features straight, fine vertical graining that produces outstanding results. Accessorized with: simulated divided lights (SDL) and a dentil shelf, it's no surprise it's become a favorite. These fir doors create fine details and give your home a traditional, craftsman appeal.

ALL FIR DOORS ARE SHOWN PRE-FINISHED



SHAKER PROFILE DOORS



🔥 20 MIN FIRE RATED 📏 10" BOTTOM RAIL ● IN STOCK ● EXTENDED LEAD TIME



FIR CRAFTSMAN DOOR

DIRECT GLAZED

DRF3C & DRF3C80 & MATCHING SIDELITES ARE ONLY AVAILABLE WITH GLASS



GLASS OPTIONS



● IN STOCK ● EXTENDED LEAD TIME ● EXTENDED LEAD TIME

8'0"



SOLP

8'0"



SPRP

6'8"



G000

8'0"



G000

8'0"



B01P

8'0"



B02P

8'0"



ARTP

8'0"



ARZZ

8'0"



KENP

8'0"



SOLP

8'0"



SPRP

FIR SHAKER DOOR

SHAKER PROFILE

6'8"

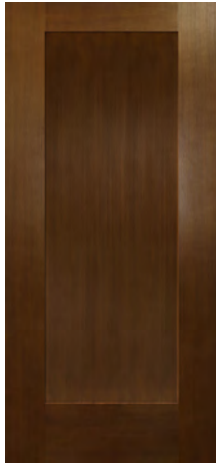

2'8" • 2'10" • 3'0"

DRF1K

SHAKER PROFILE

The straightforward shaker design showcases the beauty that minimal design can offer. Our shaker focuses on simplicity and is easily adaptable for any home's exterior.

FIR 2 PANEL SHAKER DOOR

*GLASS OPTIONS VIA SOLUTION FRAME
- SEE PAGE 25 FOR AVAILABLE TEXTURE GLASS STYLES.

6'8"

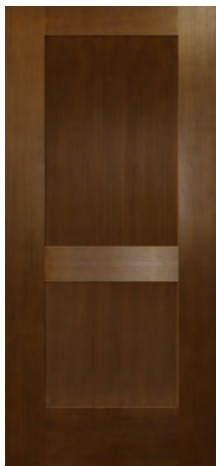

2'8" • 2'10" • 3'0"

DRF2K

6'8"



22"x 36" HALF LITE
Solution Frame*

THREE PANEL CRAFTSMAN DOOR



*GLASS OPTIONS VIA SOLUTION FRAME - SEE PAGE 25 FOR AVAILABLE TEXTURE GLASS STYLES.

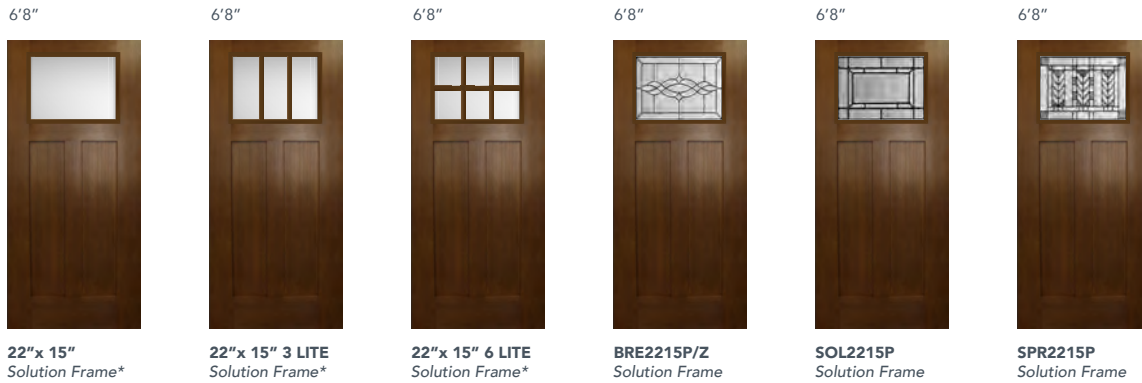

5 PANEL SHAKER DOOR

*GLASS OPTIONS VIA SOLUTION FRAME
- SEE PAGE 25 FOR AVAILABLE TEXTURE GLASS STYLES.

6'8"

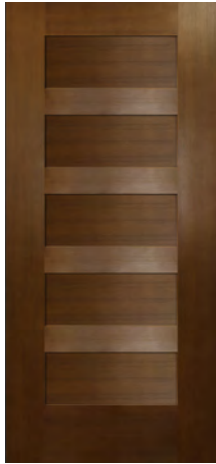

2'8" • 2'10" • 3'0"

DRF50

● IN STOCK

● EXTENDED LEAD TIME

6'8"

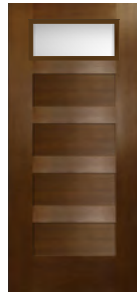

22" x 8"
Solution Frame*

6'8"

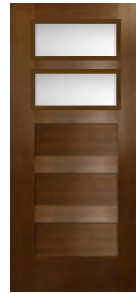

22" x 8"
Solution Frame*

6'8"



22" x 8"
Solution Frame*



Fir Series • DRF3C • Glass G000 • SDL ACSD23006 • Dentil Shelf ACDSFT2704

FIR SERIES ACCESSORIES



3 Lite



6'8" ACSDF23001
8'0" ACSDF23005

SIMULATED DIVIDED LIGHTS "SDL" BARS

Plastpro Simulated Divided Lights (SDL Bars) can be used on the interior and exterior of our doors and help create personalized, unique looks. They are easy to install and will not rot or absorb moisture.

6 Lite



6'8" ACSDF23002
8'0" ACSDF23006

Sidelite



ACSDF23004

FEATURES & BENEFITS

- Easy installation using common wood working tools and equipment.
- Will not rot or absorb moisture and resists the growth of fungus and mildew.
- Closed cellular structure prevents paint from peeling off the surface.
- Will not warp or crack when properly installed, or be affected by UV rays when properly coated.

4 Block Dentil Shelf (DRF3C)



ACDSFT2704

DENTIL SHELF

Plastpro Dentil Shelves are made of lightweight High Density Polyurethane (HDP) and will not warp, rot, or crack. HDP is an excellent alternative to traditional wood products.

4 Block Dentil Shelf (DRF3F)



ACDSFT2404

FEATURES & BENEFITS

- Recreate Classic Design
- Create Custom Looks
- Affordable

















































OAK SERIES



Dressed in a rich oak grain texture, our Oak Series gives a classic look to your home. Oak doors come in many panel designs. Mix and match these styles with our entire glass line to find the combination that best brings out your homes unique characteristics. These doors create a timeless look that will never go out of style.

ALL OAK DOORS ARE SHOWN PRE-FINISHED

DOOR OVERVIEW

<p>6'8"</p> <p>2'0" • 2'4" • 2'6" • 2'8" • 2'10" • 3'0" • 3'6"</p>  <p>DRG00</p> 	<p>7'0"</p> <p>2'0" • 2'4" • 2'6" • 2'8" • 2'10" • 3'0" • 3'6"</p>  <p>DRG0070</p> 	<p>8'0"</p> <p>2'0" • 2'4" • 2'6" • 2'8" • 2'10" • 3'0" • 3'6"</p>  <p>DRG0080</p> 	<p>6'8"</p> <p>3'0"</p>  <p>DRG20</p> 	<p>8'0"</p> <p>6'8"</p> <p>2'8" • 2'10" • 3'0"</p>  <p>DRG29 DRG2980</p> 	<p>6'8"</p> <p>3'0"</p>  <p>DRG3E</p> 
<p>6'8"</p> <p>3'0"</p>  <p>DRG3P</p> 	<p>8'0"</p> <p>2'8" • 3'0" • 3'6"</p>  <p>DRG3080</p> 	<p>7'0"</p> <p>6'8"</p> <p>3'0" (3'0" in 7'0" extended lead time)</p>  <p>DRG31 DRG3170</p> 	<p>6'8"</p> <p>2'6" • 2'8" • 2'10" • 3'0"</p>  <p>DRG40</p> 	<p>6'8"</p> <p>2'8" • 3'0"</p>  <p>DRG41</p> 	<p>7'0"</p> <p>3'0"</p>  <p>DRG4170</p> 
<p>8'0"</p> <p>2'8" • 3'0"</p>  <p>DRG4180</p> 	<p>6'8"</p> <p>2'8" • 2'10" • 3'0"</p>  <p>DRG49</p> 	<p>6'8"</p> <p>3'0"</p>  <p>DRG6B</p> 	<p>6'8"</p> <p>3'0"</p>  <p>DRG6C</p> 	<p>8'0"</p> <p>6'8"</p> <p>2'6" • 3'0" (2'8 & 3'6" avail in 8'0 only)</p>  <p>DRG60 DRG6080</p> 	<p>6'8"</p> <p>2'8" • 3'0"</p>  <p>DRG61</p> 
<p>7'0"</p> <p>2'8" • 2'10" • 3'0"</p>  <p>DRG6170</p> 	<p>8'0"</p> <p>2'8" • 2'10" • 3'0"</p>  <p>DRG6180</p> 	<p>6'8"</p> <p>2'8" • 2'10" • 3'0"</p>  <p>DRG63</p> 	<p>8'0"</p> <p>6'8"</p> <p>3'0" • (3'6" available only in 8' Door)</p>  <p>DRG80 DRG8080</p> 	<p>6'8"</p> <p>2'8" • 3'0"</p>  <p>DRG90</p> 	<p>8'0"</p> <p>3'0"</p>  <p>DRG9180</p> 

OAK FLUSH PANEL DOOR



GLASS OPTIONS

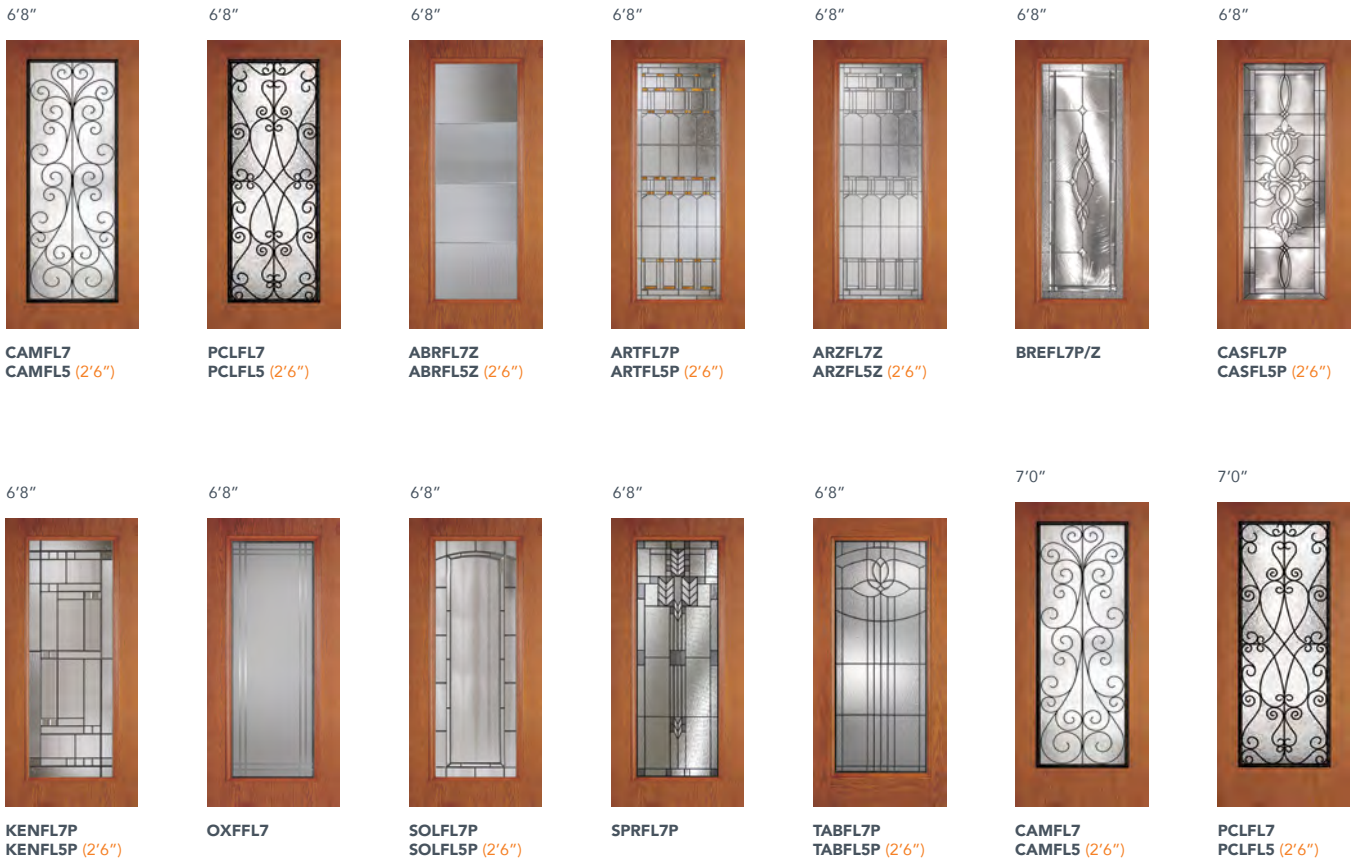

● IN STOCK ● EXTENDED LEAD TIME

OAK GRAIN FLUSH PANEL DOOR

7'0"



ABRFL7Z
ABRFL5Z (2'6")

7'0"



ARTFL7P
ARTFL5P (2'6")

7'0"



ARZFL7Z
ARZFL5Z (2'6")

7'0"



BREFL7P/Z
BREFL5P/Z (2'6")

7'0"



CASFL7P
CASFL5P (2'6")

7'0"



KENFL7P
KENFL5P (2'6")

7'0"



OXFFL7

7'0"



SOLFL7
SOLFL5 (2'6")

7'0"



SPRFL7

7'0"



TABFL7P
TABFL5P (2'6")

8'0"



CAMFL8
CAMFL6 (2'6")

8'0"



PCLFL8
PCLFL6 (2'6")

8'0"



ABRFL8Z
ABRFL6Z (2'6")

8'0"



ARTFL8P

8'0"



ARZFL8Z

8'0"



BREFL8P/Z

8'0"



CASFL8P

8'0"



KENFL8P

8'0"



OXFFL8

8'0"



SOLFL8P

8'0"



TABFL8P

8'0"



CAMFL1 & FL2

8'0"



PCLFL1 & FL2

8'0"



ABRFL1Z & FL2Z

8'0"



ARTFL1P & FL2P

8'0"



ARZFL1Z & FL2Z

8'0"



BREFL1P/Z
& FL2P/Z

8'0"



CASFL1P & FL2P

OAK GRAIN FLUSH PANEL DOOR

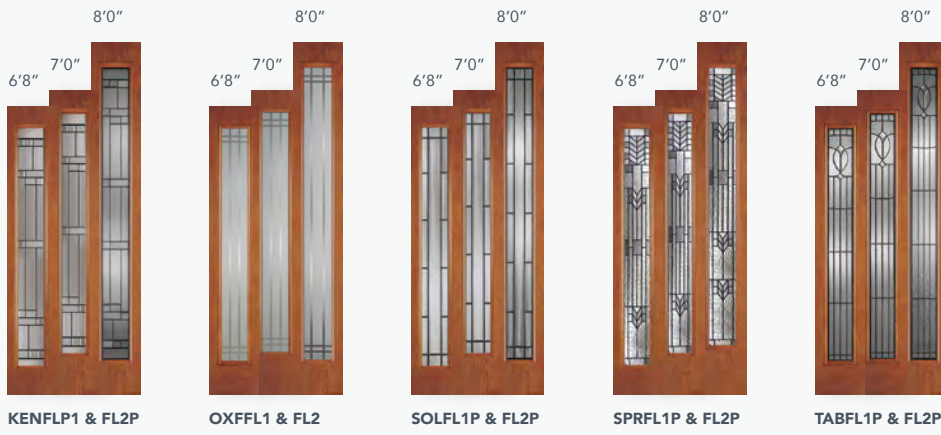

OAK 3/4 HERITAGE DOOR

6'8"



DRG20



SLG3E

10" • 12"

30"

GLASS OPTIONS

6'8"



BRE3V2P/Z

6'8"



CAS3V2P

6'8"



TAB3V2P

6'8"



CAS343P

6'8"



BRE341P/Z

6'8"



CAS341P

6'8"



TAB341P

● IN STOCK

● EXTENDED LEAD TIME

OAK

3/4 TWO PANEL DOOR



GLASS OPTIONS

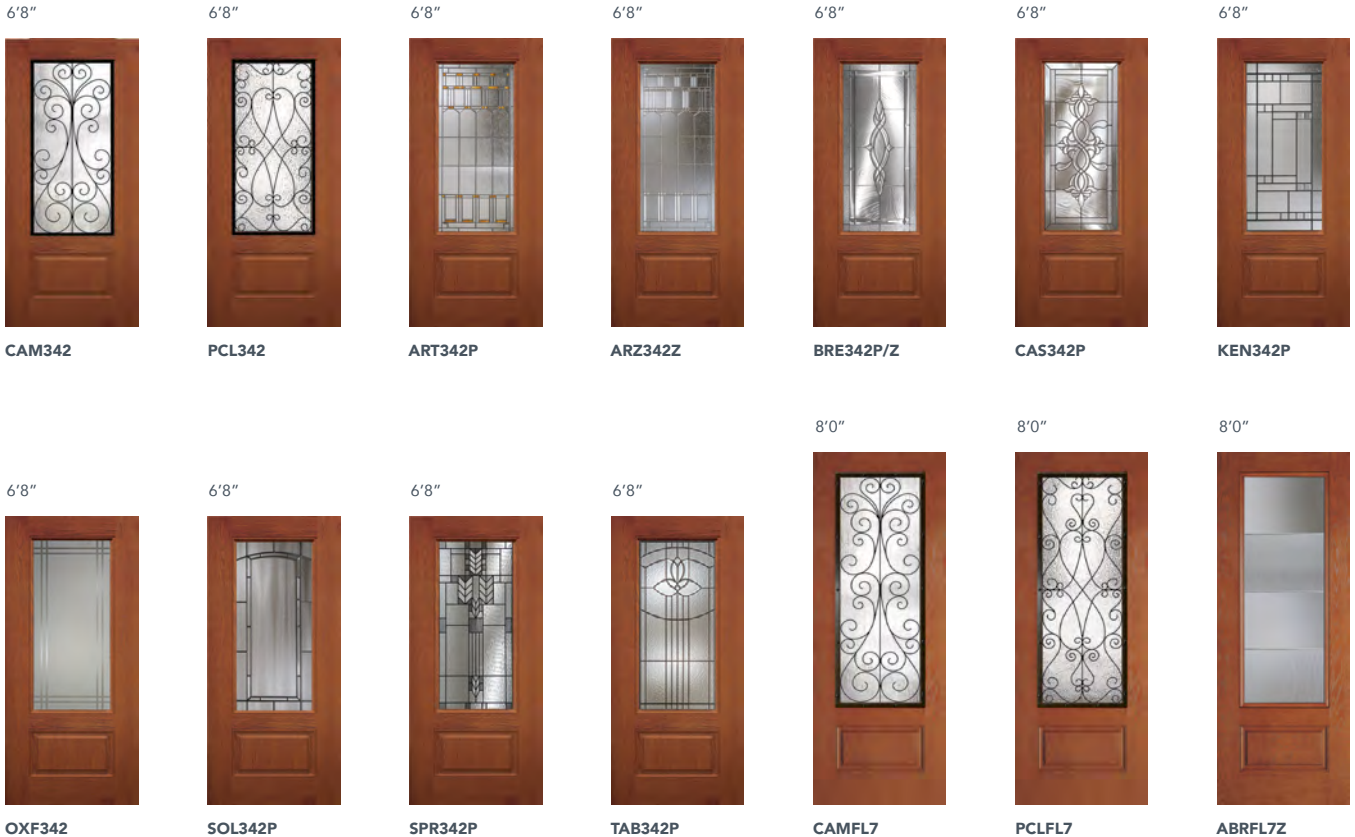

● IN STOCK ● EXTENDED LEAD TIME

3/4 TWO PANEL DOOR

8'0"

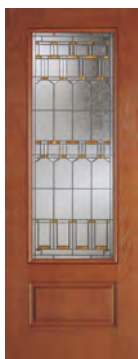

ARTFL7P

8'0"



ARZFL7Z

8'0"



BREFL7P/Z

8'0"



CASFL7P

8'0"



KENFL7P

8'0"



OXFFL7

8'0"



SOLFL7P

8'0"

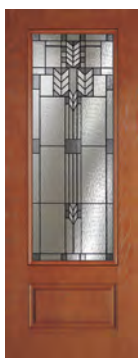

SPRFL7P

8'0"



TABFL7P

8'0"



CAMFL1

8'0"



PCLFL1

8'0"



ABRFL1Z

8'0"



ART341P & FL1P

8'0"



ARZ341Z & FL1Z

8'0"



BRE341P/Z & FL1P/Z

8'0"



CAS341 & FL1P

8'0"



KEN341 & FL1

8'0"



OXF341 & FL1

8'0"



SOL341P & FL1P

8'0"



SPR341P & FL1P

8'0"



TAB341P & FL1P

OAK 3/4 ELITE DOOR

6'8"



DRG3E



SLG3E

3'0"

1'0" • 1'2"

GLASS OPTIONS

6'8"



BRE3V2P/Z

6'8"



CAS3V2P

6'8"



TAB3V2P

6'8"



CAS343P

6'8"



BREFL1P/Z

6'8"



CAS341P

6'8"



TAB341P

OAK 3/4 PREMIUM DOOR

6'8"



DRG3P



SLG3P

3'0"

1'0" • 1'2"

GLASS OPTIONS

6'8"



BRE3V2P/Z

6'8"



CAS3V2P

6'8"



TAB3V2P

6'8"



BRE3V1P/Z

6'8"



CAS3V1P

OAK 3/4 PANEL DOOR

8'0"



2'8" • 3'0" • 3'6"

DRG3080

1'0" • 1'2"

SLG3080

GLASS OPTIONS

8'0"



BRE3V3P/Z

8'0"



CAS3V3P

8'0"

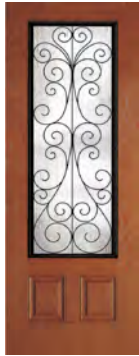

CAMFL7

8'0"



PCLFL7

8'0"



ABRFL7Z

8'0"



ARTFL7P

8'0"



ARZFL7Z

8'0"



BREFL7P/Z

8'0"



CASFL7P

8'0"



KENFL7P

8'0"



OXFFL7

8'0"



SOLFL7P

8'0"



SPRFL7P

8'0"



TABFL7P

3/4 THREE PANEL DOOR

8'0"



CAMFL1

8'0"



PCLFL1

8'0"



ABRFL1Z

8'0"



ARTFL1P

8'0"



ARZFL1Z

8'0"

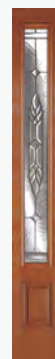

BREFL1P/Z

8'0"



CASFL1P

8'0"

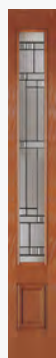

KENFL1P

8'0"



OXFFL1

8'0"



SOLFL1P

8'0"



SPRFL1P

8'0"

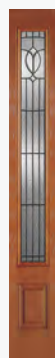

TABFL1P

OAK THREE PANEL DOOR

6'8"



DRG31

7'0"



DRG3170

3'0"

3'0"

● IN STOCK

● EXTENDED LEAD TIME

OAK FOUR PANEL BLANK TOP DOOR

6'8"



DRG40

SLG60

GLASS OPTIONS

6'8"



CASHR1P

6'8"



TABHR1P

6'8"



ARTHL4P

6'8"



ARZHL4Z

6'8"



BREHL4P/Z

6'8"



CASHL4P

6'8"



KENHL4P

6'8"



OXFHL4

6'8"



SOLHL4P

6'8"

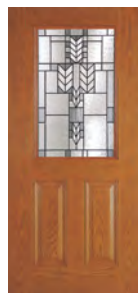

SPRHL4P

6'8"



TABHL4P

FOUR PANEL BLANK TOP DOOR

6'8"



ARTHL2P

6'8"

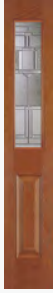

ARZHL2Z

6'8"



BREHL2P/Z

6'8"

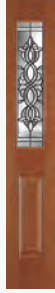

CASHL2P

6'8"



KENHL2P

6'8"



OXFHL2

6'8"

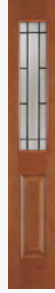

SOLHL2P

6'8"



SPRHL2P

6'8"



TABFL1P



Oak Series • DRG29 • Glass OXF342

OAK TRUE FOUR PANEL DOOR



GLASS OPTIONS



● IN STOCK ● EXTENDED LEAD TIME

TRUE FOUR PANEL DOOR

8'0"

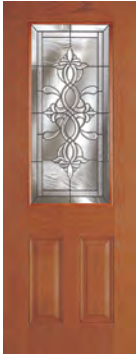

CAS342P

8'0"



KEN342P

8'0"



OXF342

8'0"



SOL342P

8'0"

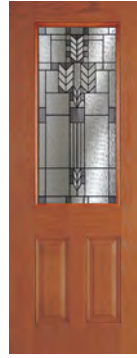

SPR342P

8'0"



TAB342P

8'0"



ARTHL2P & 341P

8'0"



ARZHL2Z & 341Z

8'0"



BREHL2P/Z & 341P/Z

8'0"



CASHL2P & 341P

8'0"



KENHL2P & 341P

8'0"



OXFHL2 & 341

8'0"

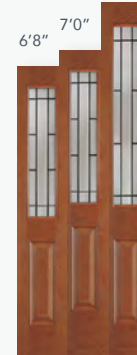

SOLHL2P & 341P

8'0"

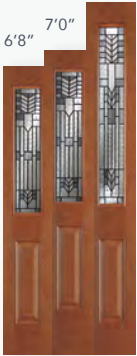

SPRHL2P & 341P

8'0"



TABFL1P & 341P

OAK

3/4 FOUR PANEL DOOR

6'8"



2'8" • 2'10" • 3'0"

1'0" • 1'2"

DRG49

SLG49

GLASS OPTIONS

6'8"

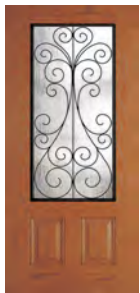

CAM342

6'8"



PCL342

6'8"

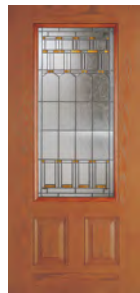

ART342P

6'8"



ARZ342Z

6'8"



BRE342P/Z

6'8"



CAS342P

6'8"



KEN342P

6'8"



OXF342

6'8"



SOL342P

6'8"



SPR342P

6'8"



TAB342P

3/4 FOUR PANEL DOOR

6'8"



ART341P

6'8"



ARZ341Z

6'8"



BRE341P/Z

6'8"



CAS341P

6'8"



KEN341P

6'8"



OXF341

6'8"



SPR341P

6'8"



SOL341P

6'8"



TAB341P

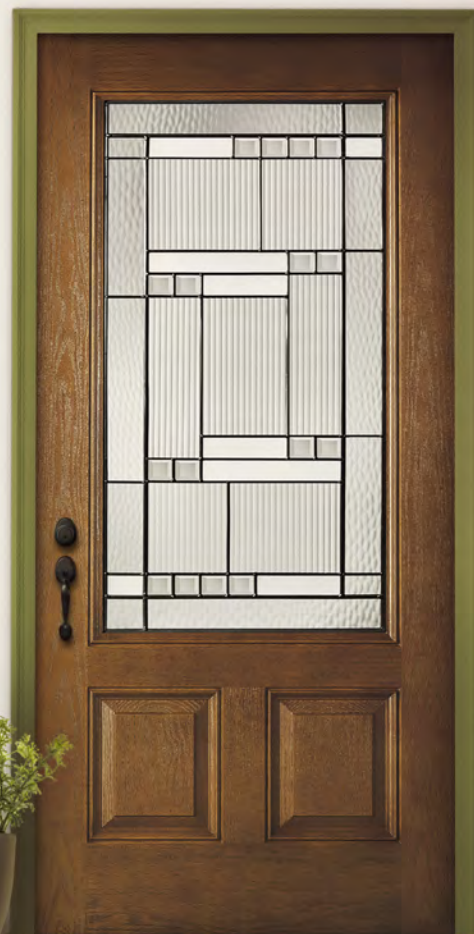

Oak Series • DRG49 • Glass KEN342P



Oak Series • DRG6080

OAK SIX PANEL CRAFTSMAN DOOR

6'8"



3'0"

DRG6C



OAK GRAIN ACCESSORIES AVAILABLE ON PAGE 99.

GLASS OPTIONS

6'8"



ARTTL3P

6'8"



ARZTL3Z

6'8"



BRETL3P/Z

6'8"



OXF3L3

6'8"



SOL3L3P

6'8"

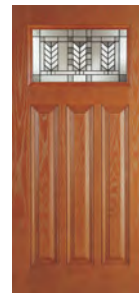

SPRTL3P

● IN STOCK

● EXTENDED LEAD TIME

OAK SIX PANEL DOOR



GLASS OPTIONS



● IN STOCK ● EXTENDED LEAD TIME

OAK SIX PANEL UTILITY DOOR



GLASS OPTIONS



● IN STOCK ● EXTENDED LEAD TIME

SIX PANEL UTILITY DOOR

7'0"



SOLHL4P

7'0"



SPRHL4P

7'0"



TABHL4P

8'0"

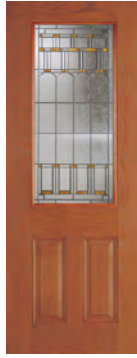

ART342P

8'0"

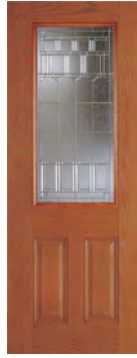

ARZ342Z

8'0"



BRE342P/Z

8'0"

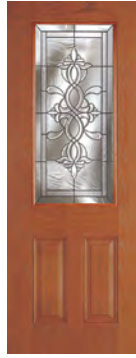

CAS342P

8'0"



KEN342P

8'0"



OXF342

8'0"



SOL342P

8'0"



SPR342P

8'0"



TAB342P

6'8" 7'0"



ARTHL2P

6'8" 7'0"



ARZHL2Z

6'8" 7'0"



BREHL2P/Z

6'8" 7'0"

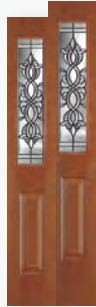

CASHL2P

6'8" 7'0"



KENHL2P

6'8" 7'0"



OXFHL2

6'8" 7'0"



SOLHL2P

6'8" 7'0"



SPRHL2P

6'8" 7'0"



TABFL1P

Oak Series • DRG00 • Glass BREFL7Z



OAK TRUE SIX PANEL NARROW DOOR

6'8"



DRG63



SLG60

2'8" • 2'10" • 3'0"

1'0" • 1'2"

GLASS OPTIONS

6'8"

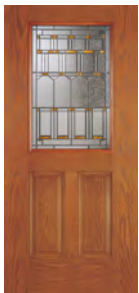

ARTHL4P

6'8"



ARZHL4Z

6'8"



BREHL4P/Z

6'8"



CASHL4P

6'8"

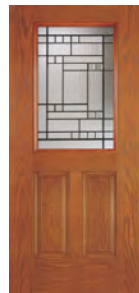

KENHL4P

6'8"



OXFHL4

6'8"

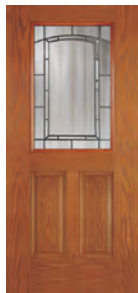

SOLHL4P

6'8"

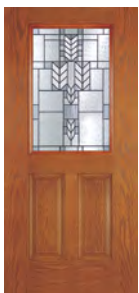

SPRHL4P

6'8"



TABHL4P

TRUE SIX PANEL NARROW DOOR

6'8"



ARTHL2P

6'8"

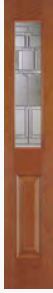

ARZHL2Z

6'8"



BREHL2ZP/Z

6'8"



CASHL2P

6'8"

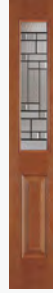

KENHL2P

6'8"



OXFHL2

6'8"



SOLHL2P

6'8"



SPRHL2P

6'8"



TABFL1P



Oak Series • DRG80 • Glass ART8C2P

OAK EIGHT PANEL DOOR



GLASS OPTIONS



OAK NINE PANEL DOOR

6'8"

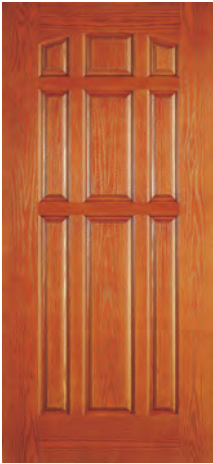

2'8" • 3'0"

DRG90

GLASS OPTIONS

6'8"



BRE9P1P/Z

6'8"



SPR9P1P

OAK NINE PANEL DOOR

8'0"



3'0"

DRG9180

GLASS OPTIONS

8'0"



ART341P

8'0"



ARZ341Z

8'0"



BRE341P/Z

8'0"



CAS341P

8'0"



KEN341P

8'0"



OXF341

8'0"



SOL341P

8'0"



SPR341P

8'0"



TAB341P

OAK SERIES ACCESSORIES



4 Block Dentil Shelf



ACDSGT2704

DENTIL SHELF

Plastpro Dentil Shelves are made of lightweight High Density Polyurethane (HDP) and will not warp, rot, or crack. HDP is an excellent alternative to traditional wood products.

16 Block Dentil Shelf



ACDSGT2716

FEATURES & BENEFITS

- Recreate Classic Design
- Create Custom Looks
- Affordable

6'8"



DRG6C
ARTTL3P
ACDSGT2704

6'8"



DRG6C
BRETLL3Z
ACDSGT2716

6'8"



DRG6C
SOLTLL3P
ACDSGT2716

6'8"













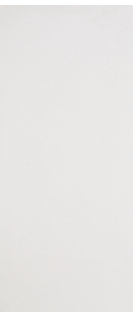



























DRG6C
SPRTL3P
ACDSGT2704

SMOOTH SERIES





































Our Smooth Series are made with a pre-pigmented white skin; its simplicity gives a modern design and feel to any home. Our Smooth skin incorporated with a variety of panel designs and glass options, gives a clean, minimal look to any of our fiberglass doors.

DOOR OVERVIEW

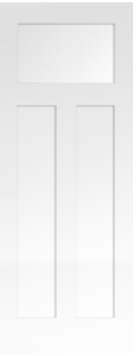
<p>6'8"</p>  <p>2'0" • 2'4" • 2'6" • 2'8" • 2'10" • 3'0" • 3'6"</p>	<p>7'0"</p>  <p>2'0" • 2'4" • 2'6" • 2'8" • 2'10" • 3'0" • 3'6"</p>	<p>8'0"</p>  <p>2'0" • 2'4" • 2'6" • 2'8" • 2'10" • 3'0" • 3'6"</p>	<p>6'8"</p>  <p>2'8" • 2'10" • 3'0"</p>	<p>8'0"</p>  <p>2'8" • 2'10" • 3'0"</p>	<p>6'8"</p>  <p>2'8" • 2'10" • 3'0"</p>
<p>DRS500</p> 	<p>DRS0070</p> 	<p>DRS0080</p> 	<p>DRS2B</p> 	<p>DRS2B80</p> 	<p>DRS2D</p> 
<p>8'0"</p>  <p>2'8" • 2'10" • 3'0"</p>	<p>6'8"</p>  <p>2'8" • 2'10" • 3'0"</p>	<p>8'0"</p>  <p>2'8" • 2'10" • 3'0"</p>	<p>6'8"</p>  <p>3'0"</p>	<p>6'8"</p>  <p>2'8" • 2'10" • 3'0"</p>	<p>8'0"</p>  <p>2'8" • 2'10" • 3'0"</p>
<p>DRS2D80</p> 	<p>DRS2G</p> 	<p>DRS2G80</p> 	<p>DRS20</p>	<p>DRS29</p> 	<p>DRS2980</p> 
<p>6'8"</p>  <p>3'0" (Only available with glass)</p>	<p>8'0"</p>  <p>3'0" (Only available with glass)</p>	<p>6'8"</p>  <p>3'0"</p>	<p>6'8"</p>  <p>3'0"</p>	<p>8'0"</p>  <p>2'8" • 3'0" • 3'6"</p>	<p>6'8"</p>  <p>3'0"</p>
<p>DRS3C</p>	<p>DRS3C80</p>	<p>DRS3E</p>	<p>DRS3P</p>	<p>DRS3080</p>	<p>DRS31</p>
<p>7'0"</p>  <p>3'0"</p>	<p>6'8"</p>  <p>2'8" • 2'10" • 3'0"</p>	<p>6'8"</p>  <p>2'8" • 3'0"</p>	<p>7'0"</p>  <p>3'0"</p>	<p>8'0"</p>  <p>2'8" • 3'0"</p>	<p>6'8"</p>  <p>2'6"</p>
<p>DRS3170</p> 	<p>DRS40</p> 	<p>DRS41</p> 	<p>DRS4170</p> 	<p>DRS4180</p>	<p>DRS42</p>

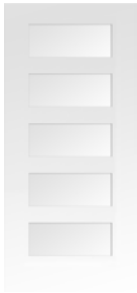
DOOR OVERVIEW

<p>6'8"</p>  <p>2'8" • 2'10" • 3'0"</p> <p>DRS49</p> 	<p>6'8"</p>  <p>2'8" • 2'10" • 3'0"</p> <p>DRS6B</p> 	<p>6'8"</p>  <p>3'0"</p> <p>DRS6C</p>	<p>6'8"</p>  <p>2'6" • 3'0"</p> <p>DRS60</p>   	<p>8'0"</p>  <p>2'6" • 2'8" • 3'0" • 3'6"</p> <p>DRS6080</p> 	<p>6'8"</p>  <p>2'8" • 2'10" • 3'0"</p> <p>DRS61</p>   
<p>7'0"</p>  <p>2'8" • 2'10" • 3'0"</p> <p>DRS6170</p> 	<p>8'0"</p>  <p>2'8" • 2'10" • 3'0"</p> <p>DRS6180</p> 	<p>6'8"</p>  <p>2'8" • 2'10" • 3'0"</p> <p>DRS63</p>	<p>6'8"</p>  <p>3'0"</p> <p>DRS80</p> 	<p>8'0"</p>  <p>3'0" • 3'6"</p> <p>DRS8080</p>	<p>6'8"</p>  <p>2'8" • 3'0"</p> <p>DRS90</p>
<p>SHAKER PROFILE DOORS</p>					
<p>6'8"</p>  <p>2'8" • 2'10" • 3'0"</p> <p>DRS1K</p> 	<p>6'8"</p>  <p>2'8" • 2'10" • 3'0"</p> <p>DRS2K</p> 	<p>6'8"</p>  <p>2'8" • 2'10" • 3'0"</p> <p>DRS3F</p> 	<p>8'0"</p>  <p>3'0" • 3'6"</p> <p>DRS3F80</p> 	<p>6'8"</p>  <p>2'8" • 2'10" • 3'0"</p> <p>DRS50</p>  	



SMOOTH FLUSH PANEL DOOR



GLASS OPTIONS

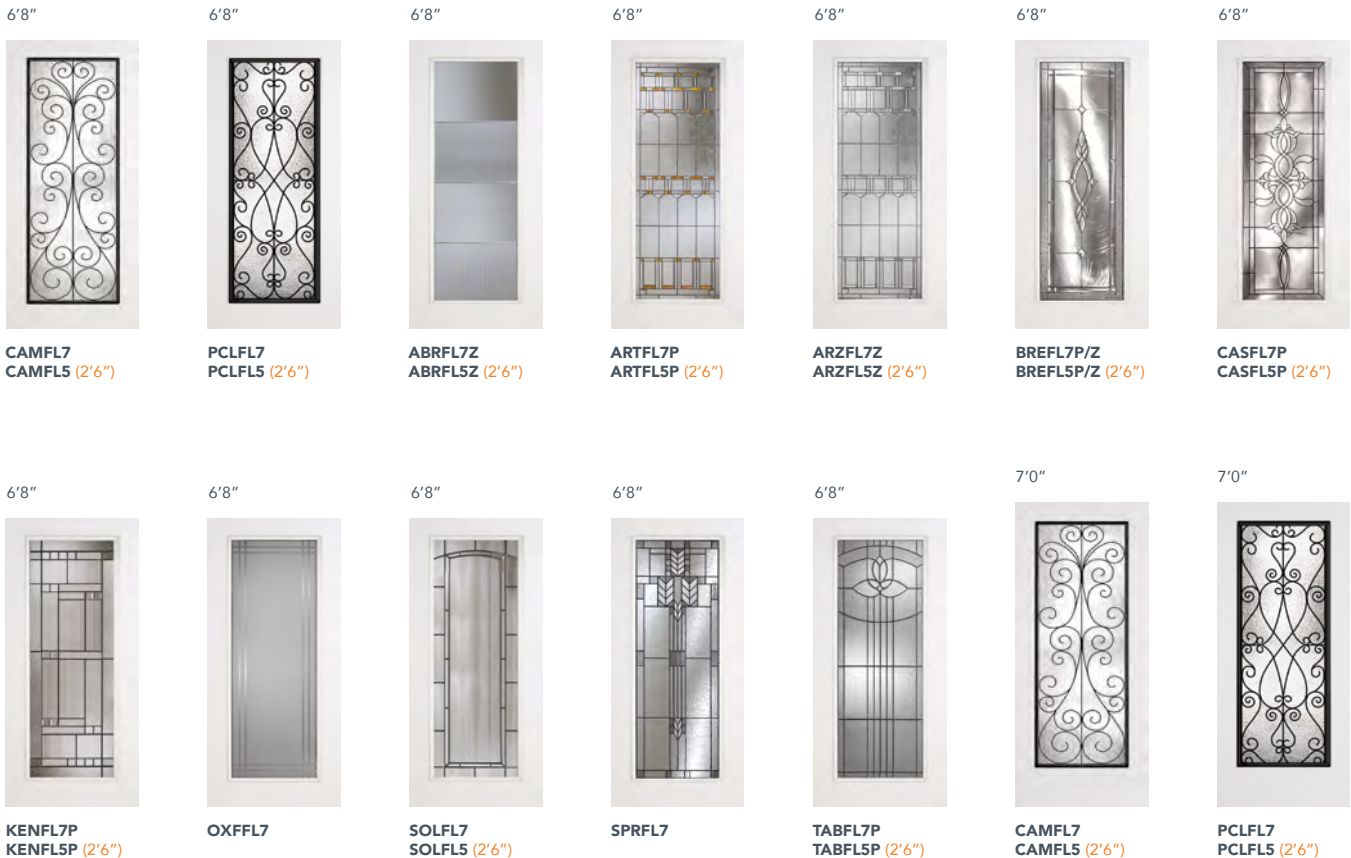

● IN STOCK ● EXTENDED LEAD TIME

SMOOTH FLUSH PANEL DOOR

7'0"

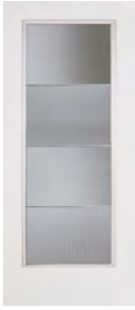

ABRFL7Z
ABRFL5Z (2'6")

7'0"

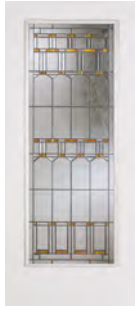

ARTFL7P
ARTFL5P (2'6")

7'0"



ARZFL7Z
ARZFL5Z (2'6")

7'0"



BREFL7P/Z
BREFL5P/Z (2'6")

7'0"



CASFL7P
CASFL5P (2'6")

7'0"



KENFL7P

7'0"



OXFFL7

7'0"



SOLFL7P
SOLFL5P (2'6")

7'0"



SPRFL7P

7'0"



TABFL7P
TABFL5P (2'6")

8'0"



CAMFL8
CAMFL6 (2'6")

8'0"



PCLFL8
PCLFL6 (2'6")

8'0"



ABRFL8Z
ABRFL6Z (2'6")

8'0"



ARTFL8P

8'0"



ARZFL8Z

8'0"



BREFL8P/Z

8'0"



CASFL8P

8'0"



KENFL8P

8'0"



OXFFL8

8'0"



SOLFL8P

8'0"



TABFL8P

8'0"



CAMFL1 & FL2

8'0"



PCLFL1 & FL2

8'0"



ABRFL1Z & FL2Z

8'0"



ARTFL1P & FL2P

8'0"



ARZFL1Z & FL2Z

8'0"



BREFL1P/Z
& FL2P/Z

8'0"



CASFL1P & FL2P

SMOOTH FLUSH PANEL DOOR



KENFLP1 & FL2P



OXFFL1 & FL2



SOLFL1P & FL2P



SPRFL1P

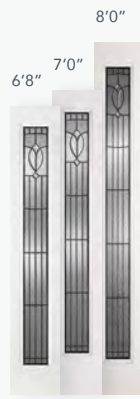

TABFL1P & FL2P



Smooth Series • DRS4170

SMOOTH TWO PANEL DOOR



GLASS OPTIONS

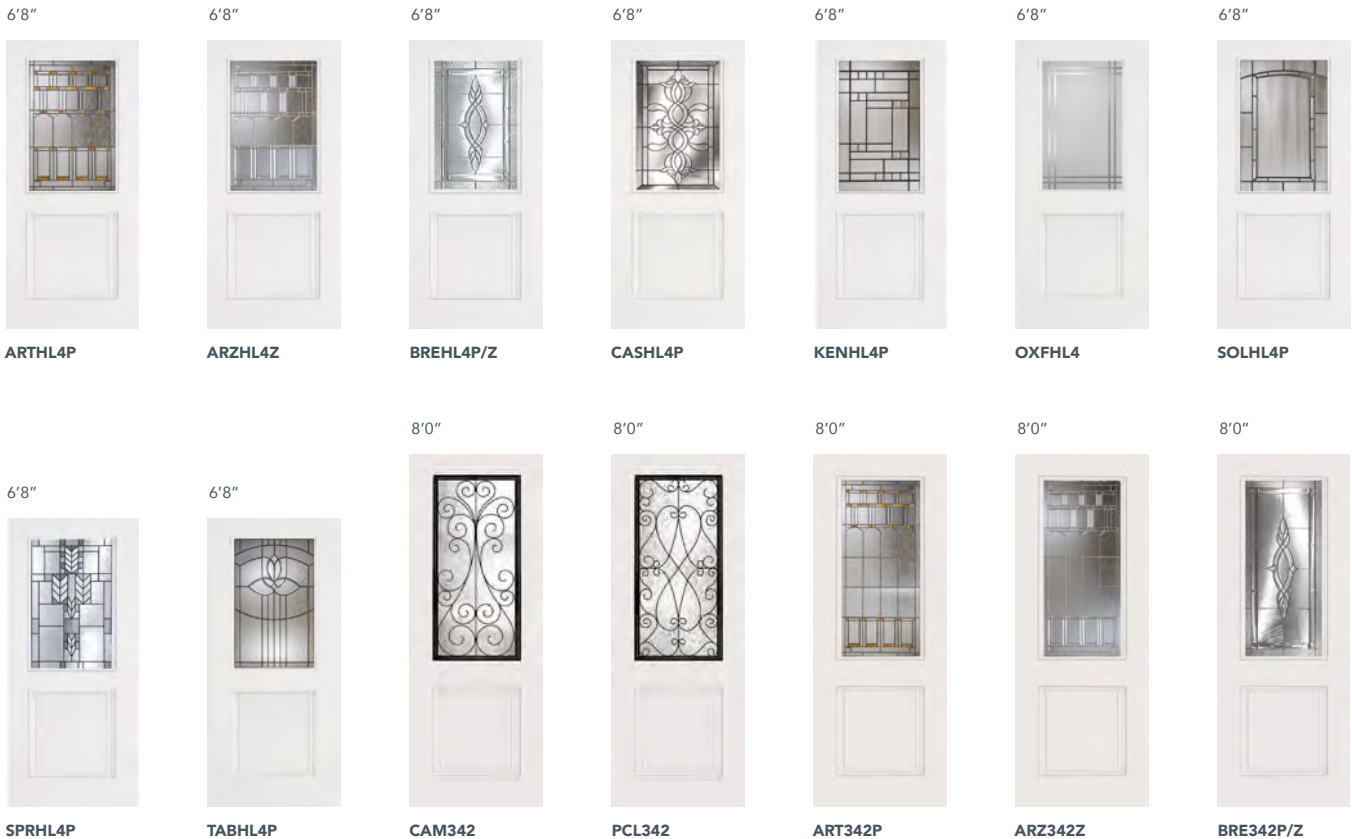

SMOOTH TWO PANEL DOOR

8'0"



CAS342P

8'0"



KEN342P

8'0"



OXF342

8'0"



SOL342P

8'0"



SPR342P

8'0"



TAB342P

8'0"



ARTHL2P & FL1P
ART341P & FL2P

8'0"



ARZHL2Z & FL1Z
ARZ341Z & FL2Z

8'0"



BREHL2P/Z & FL1P/Z
ARZ341P/Z & FL2P/Z

8'0"



CASHL2P & FL1P
CAS341P & FL2P

8'0"



KENHL2P & FL1P
KEN341P & FL2P

8'0"



OXFHL2 & FL1
OXF341 & FL2

8'0"



SOLHL2P & FL1P
SOL341P & FL2P

6'8"

6'8"

6'8"

6'8"

6'8"

6'8"

6'8"

8'0"



SPRHL2P & FL1P
SPR341P & FL2P

8'0"



TABFL1P
TAB341P & FL2P

SMOOTH TWO PANEL DOOR



GLASS OPTIONS

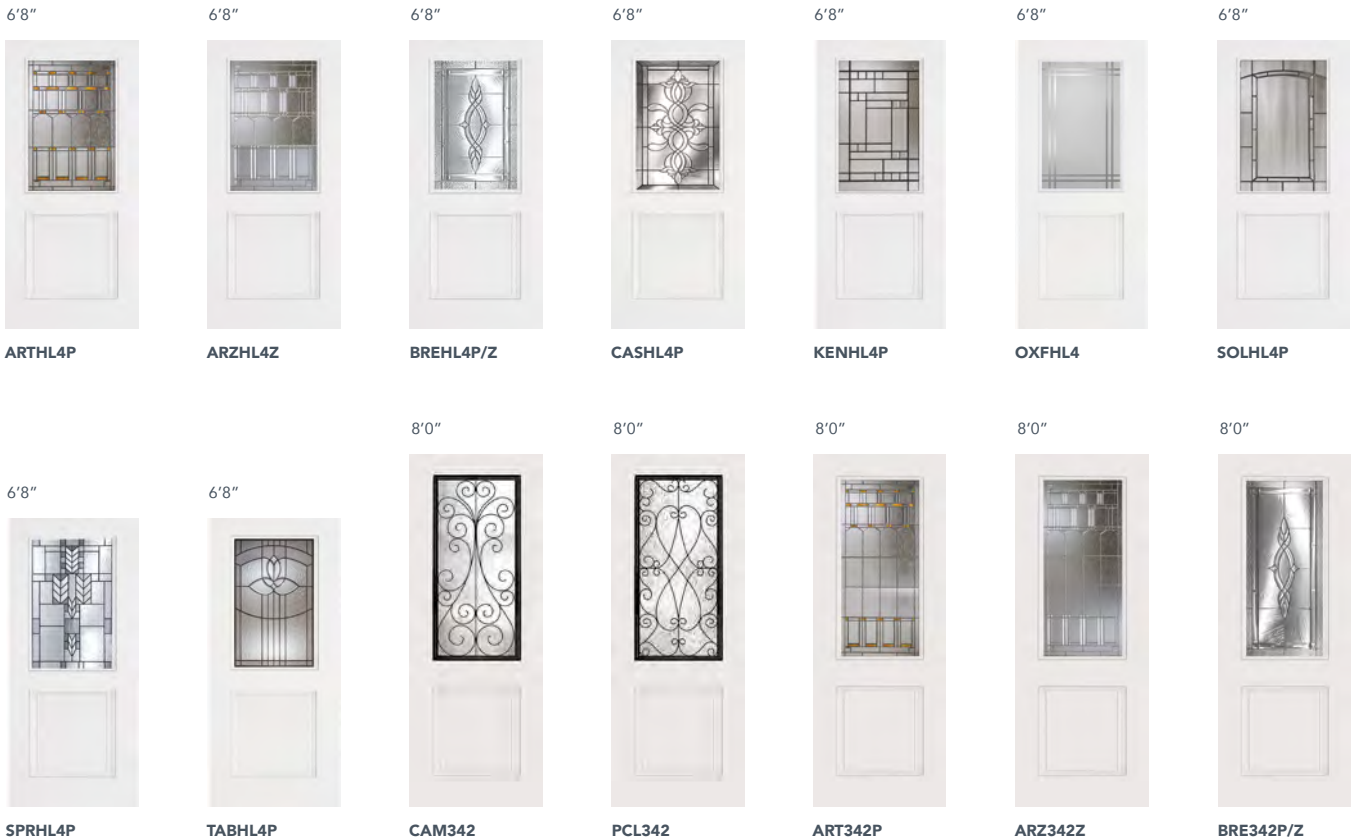

SMOOTH TWO PANEL DOOR

SQUARE PANEL & ARCH TOP

8'0"

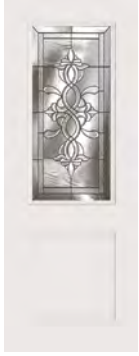

CAS342P

8'0"



KEN342P

8'0"



OXF342

8'0"



SOL342P

8'0"



SPR342P

8'0"



TAB342P

8'0"



ARTHL2P & FL1P
ART341P

8'0"



ARZHL2Z & FL1Z
ARZ341Z

8'0"



BREHL2P/Z & FL1P/Z
BRE341P/Z

8'0"



CASHL2P & FL1P
CAS341P

8'0"



KENHL2P & FL1P
KEN341P

8'0"



OXFHL2 & FL1
OXF341

8'0"



SOLHL2P & FL1P
SOL341P

8'0"



SPRHL2P & FL1P
SPR341P

8'0"



TABFL1P
TAB341



SMOOTH COTTAGE TWO PANEL DOOR

SQUARE PANEL & ARCH TOP



GLASS OPTIONS

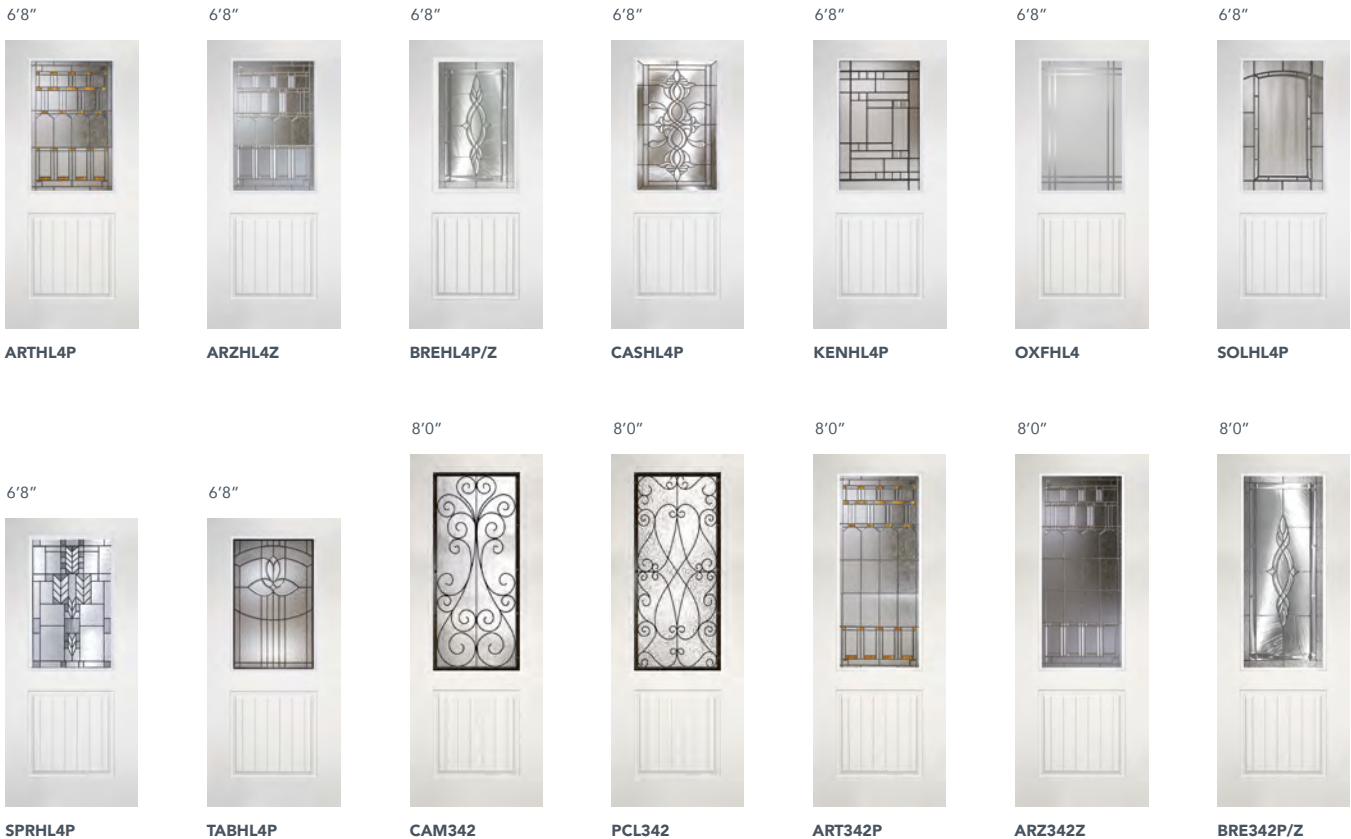

● IN STOCK ● EXTENDED LEAD TIME

SMOOTH COTTAGE TWO PANEL DOOR

8'0"



CAS342P

8'0"



KEN342P

8'0"



OXF342

8'0"

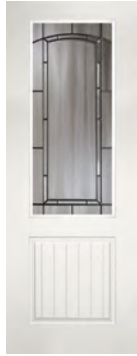

SOL342P

8'0"



SPR342P

8'0"



TAB342P

8'0"



ARTHL2P & FL1P
ART341P

8'0"



ARZHL2Z & FL1Z
ARZ341Z

8'0"



BREHL2P/Z & FL1P/Z
BRE341P/Z

8'0"



CASHL2P & FL1P
CAS341P

8'0"

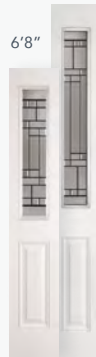

KENHL2P & FL1P
KEN341P

8'0"



OXFHL2 & FL1
OXF341

8'0"



SOLHL2P & FL1P
SOL341P

8'0"



SPRHL2P & FL1P
SPR341P

8'0"



TABFL1P
TAB341P

SMOOTH 3/4 HERITAGE DOOR

6'8"



DR520



SLS3E

3'0"

1'0" • 1'2"

GLASS OPTIONS

6'8"



BRE3V2P/Z

6'8"



CAS3V2P

6'8"



TAB3V2P

6'8"



CAS343P

6'8"



BRE341P/Z

6'8"



CAS341P

6'8"



TAB341P

SMOOTH 3/4 TWO PANEL DOOR



GLASS OPTIONS

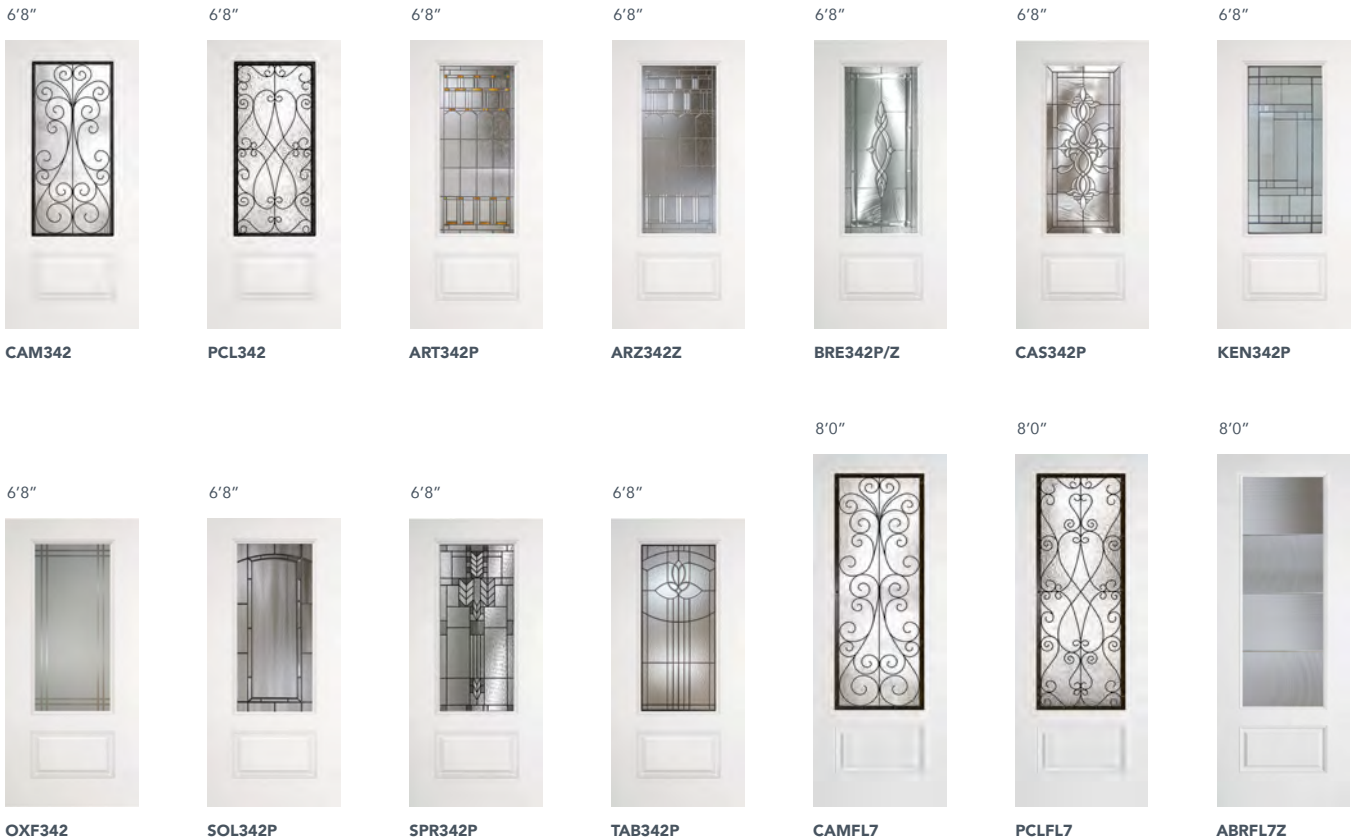

● IN STOCK ● EXTENDED LEAD TIME

3/4 TWO PANEL DOOR

8'0"



ARTFL7P

8'0"



ARZFL7Z

8'0"



BREFL7P/Z

8'0"



CASFL7P

8'0"



KENFL7P

8'0"



OXFFL7

8'0"



SOLFL7P

8'0"



SPRFL7P

8'0"



TABFL7P

8'0"



CAMFL1

8'0"



PCLFL1

8'0"



ABRFL1Z

8'0"



**ART341P
ARTFL1P**

8'0"



**ARZ341Z
ARZFL1Z**

8'0"



**BRE341P/Z
BREFL1P/Z**

8'0"



**CAS341P
CASFL1P**

8'0"

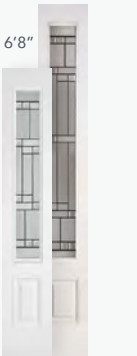

**KEN341P
KENFL1P**

8'0"

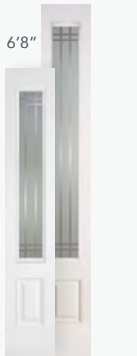

**OXF341
OXFFL1**

8'0"



**SOL341P
SOLFL1P**

8'0"

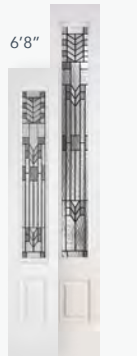

**SPR341P
SPRFL1P**

8'0"

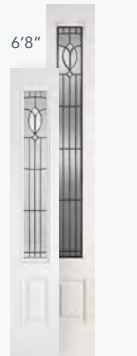

**TAB341P
TABFL1P**



Smooth Series • DR50080 • Glass KENFL8P

SMOOTH DIRECT GLAZE CRAFTSMAN

DR53C & DR53C80 & MATCHING SIDELITES ARE ONLY AVAILABLE WITH GLASS



GLASS OPTIONS

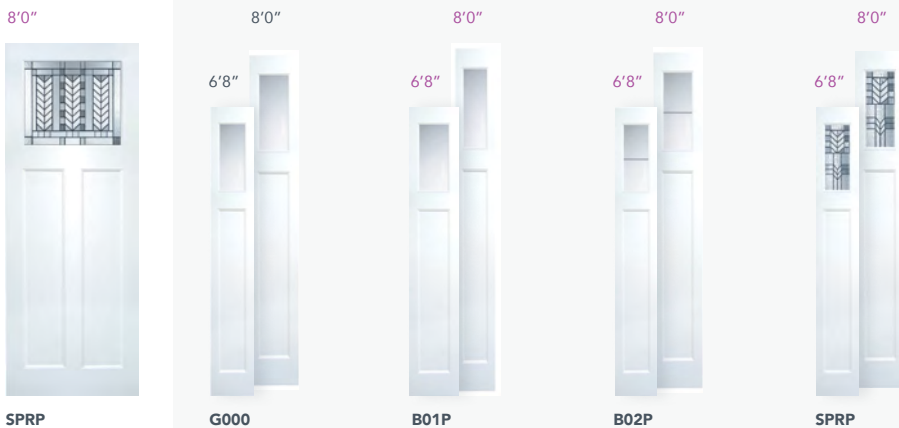

● IN STOCK ● EXTENDED LEAD TIME ● EXTENDED LEAD TIME ON GLASS

SMOOTH 3/4 ELITE DOOR

6'8"



3'0"

DR53E

SL53E

1'0" • 12"

GLASS OPTIONS

6'8"



BRE3V2P/Z

6'8"



CAS3V2P

6'8"



TAB3V2P

6'8"



CAS343P

6'8"



BREFL1P/Z

6'8"



CAS341P

6'8"



TAB341P

● IN STOCK

● EXTENDED LEAD TIME

SMOOTH 3/4 PREMIUM DOOR

6'8"



3'0"

DR53P

SLS3P

1'0" • 1'2"

GLASS OPTIONS

6'8"



BRE3V2P/Z

6'8"



CAS3V2P

6'8"



TAB3V2P

6'8"



BRE3V1P/Z

6'8"



CAS3V1P

6'8"



TABFL1P

SMOOTH 3/4 PANEL DOOR



GLASS OPTIONS

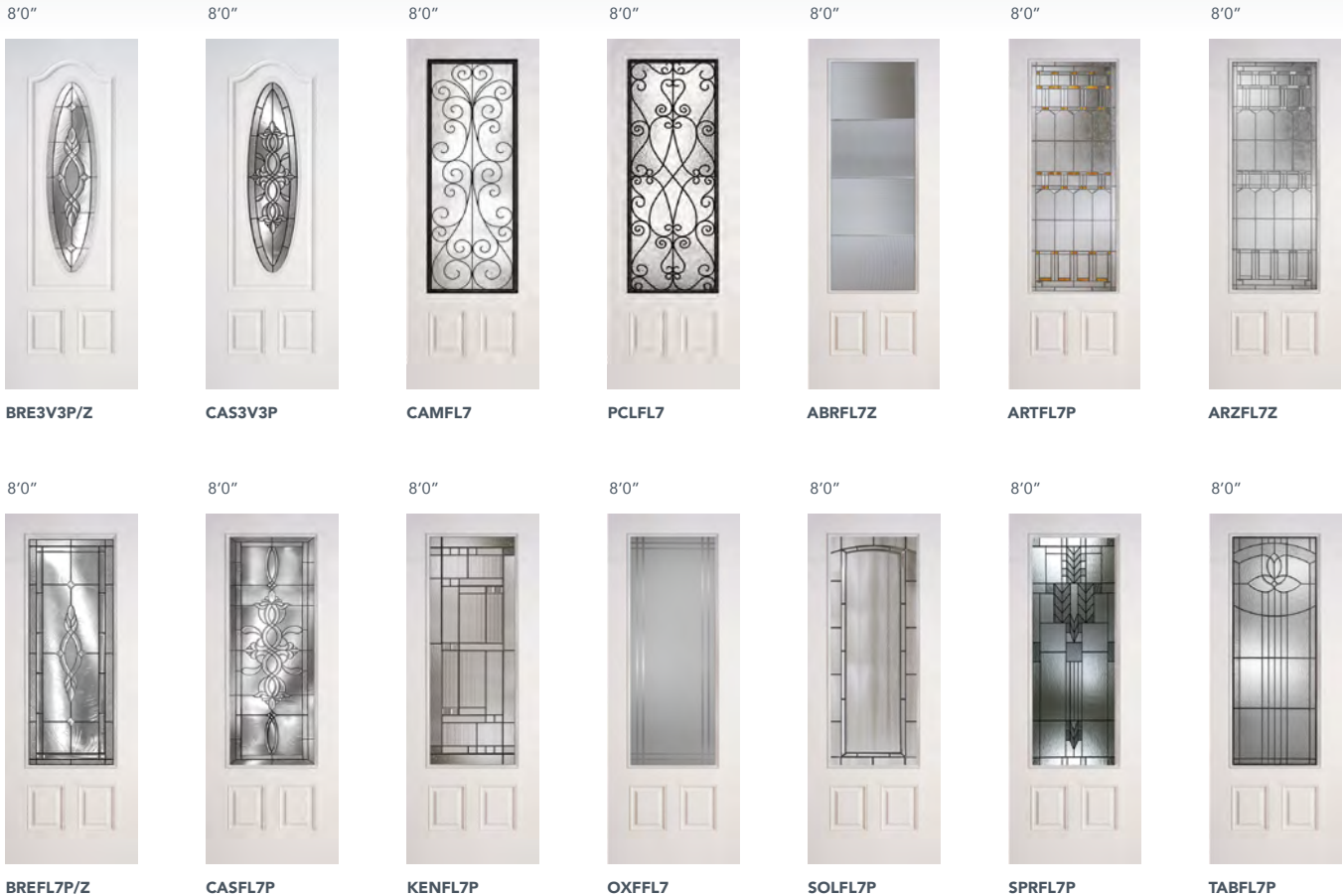

● IN STOCK ● EXTENDED LEAD TIME

3/4 THREE PANEL DOOR

8'0"



CAMFL

8'0"



PCLFL1

8'0"



ABRFL1Z

8'0"



ARTFL1P

8'0"



ARZFL1Z

8'0"



BREFL1P/Z

8'0"



CASFL1P

8'0"



KENFL1P

8'0"



OXFFL1

8'0"



SOLFL1P

8'0"



SPRFL1P

8'0"



TABFL1P

SMOOTH THREE PANEL DOOR

6'8"



DRS31

7'0"



DRS3170

3'0"

3'0"



Smooth Series • DR52980 • Glass SOLFL7P

SMOOTH FOUR PANEL BLANK TOP DOOR



DR540
DR542 (2'6" No matching sidelite) SLS60

GLASS OPTIONS

6'8"



CASHR1P

6'8"



TABHR1P

6'8"



ARTHL4P
ARHL3P (2'6")

6'8"



ARZHL4Z
ARZHL3Z (2'6")

6'8"



BREHL4P/Z

6'8"

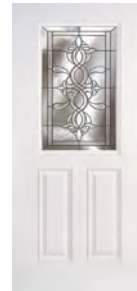

CASHL4P
CASHL3P (2'6")

6'8"



KENHL4P
KENHL3P (2'6")

6'8"



OXFHL4

6'8"



SOLHL4P
SOLHL3P (2'6")

6'8"

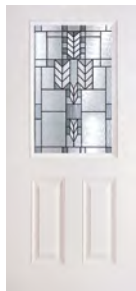

SPRHL4P

6'8"



TABHL4P
TABHL3P (2'6")

FOUR PANEL BLANK TOP DOOR

6'8"



ARTHL2P

6'8"

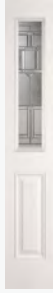

ARZHL2Z

6'8"

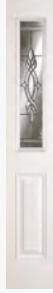

BREHL2P/Z

6'8"

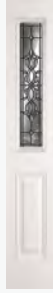

CASHL2P

6'8"



KENHL2P

6'8"



OXFHL2

6'8"

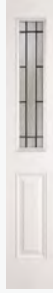

SOLHL2P

6'8"



SPRHL2P

6'8"



TABFL1P

Smooth Series • Shaker Profile • DRS50

SMOOTH TRUE FOUR PANEL DOOR



GLASS OPTIONS

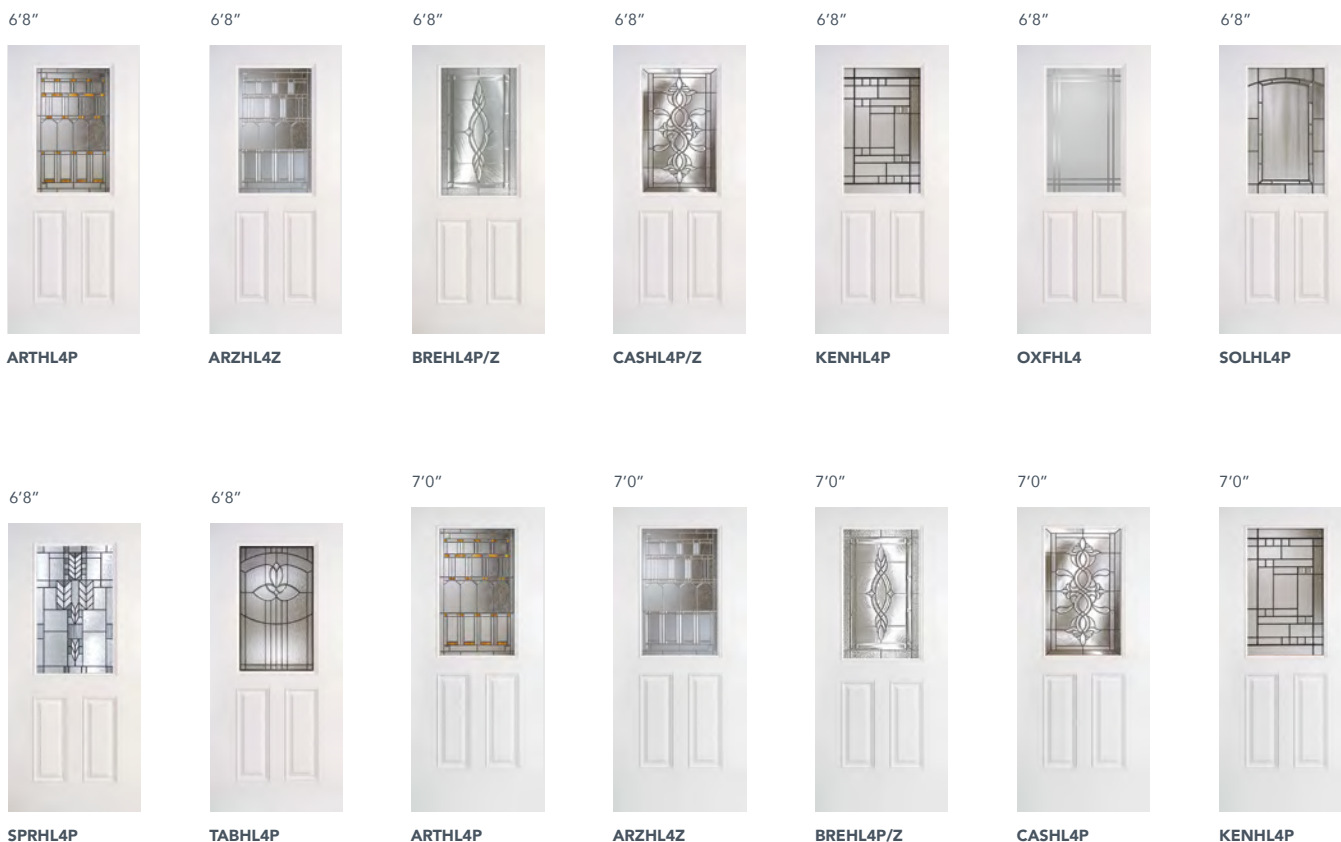

● IN STOCK ● EXTENDED LEAD TIME

TRUE FOUR PANEL DOOR

7'0"



OXFHL4

7'0"



SOLHL4P

7'0"

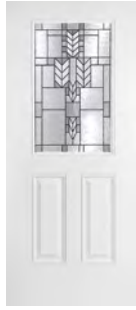

SPRHL4P

7'0"

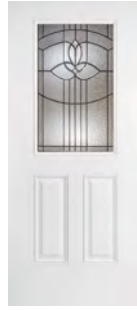

TABHL4P

8'0"



CAM342

8'0"



PCL342

8'0"

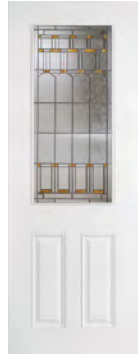

ART342P

8'0"



8'0"



BRE342P/Z

8'0"

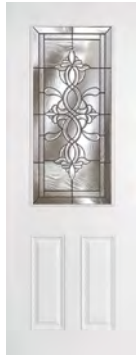

CAS342P

8'0"



KEN342P

8'0"



OXF342

8'0"



SOL342P

8'0"



SPR342P

8'0"

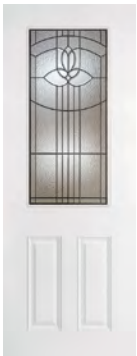

TAB342P

8'0"



ARTH2P & 341P

8'0"



ARZHL2Z & 341Z

8'0"

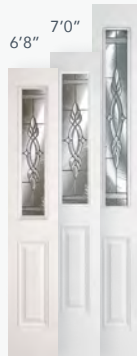

BREHL2P/Z & 341P/Z

8'0"



CASH2P & 341P

8'0"



KENHL2P & 341P

8'0"



SOLHL2P & 341P

8'0"



SPRHL2P & 341P

8'0"



BREHL1P & 341P

8'0"



TABL1P & 341P

SMOOTH 3/4 FOUR PANEL DOOR

6'8"



DR549

SLS49

GLASS OPTIONS

6'8"



CAM342

6'8"



PCL342

6'8"



ART342P

6'8"

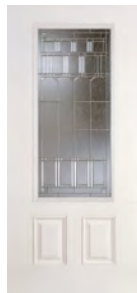

ARZ342Z

6'8"



BRE342P/Z

6'8"



CAS342P

6'8"



KEN342P

6'8"



OXF342

6'8"



SOL342P

6'8"



SPR342P

6'8"

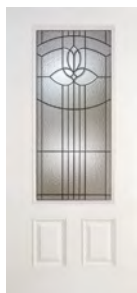

TAB342P

3/4 FOUR PANEL DOOR

6'8"



ART341P

6'8"



ARZ341Z

6'8"



BRE341P/Z

6'8"



CAS341P

6'8"



KEN341P

6'8"



OXF341

6'8"



SPR341P

6'8"



SOL341P

6'8"



TAB341P



Smooth Series • DRS1K

SMOOTH SIX PANEL CRAFTSMAN DOOR

6'8"



3'0"

DR56C



SMOOTH ACCESSORIES AVAILABLE ON PAGE 142 & 143.

6'8"



ARTTL3P

6'8"



ARZTL3Z

6'8"



BRETL3P/Z

6'8"



OXFTL3

6'8"



SOLTL3P

6'8"



SPRTL3P

SMOOTH SIX PANEL DOOR



GLASS OPTIONS

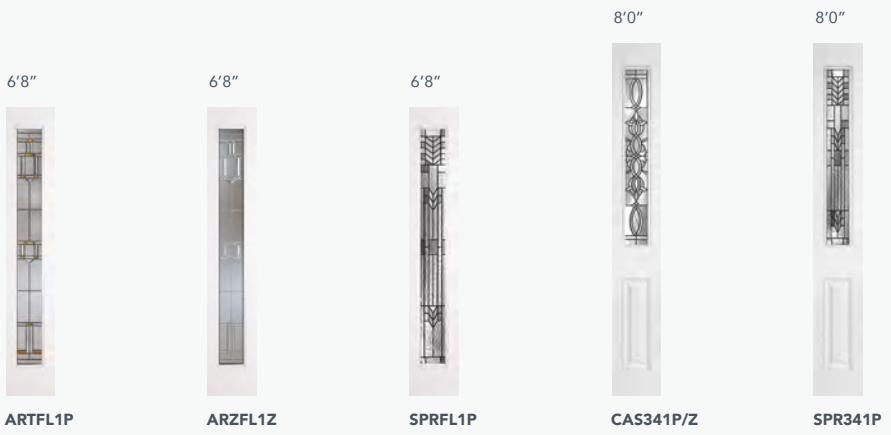
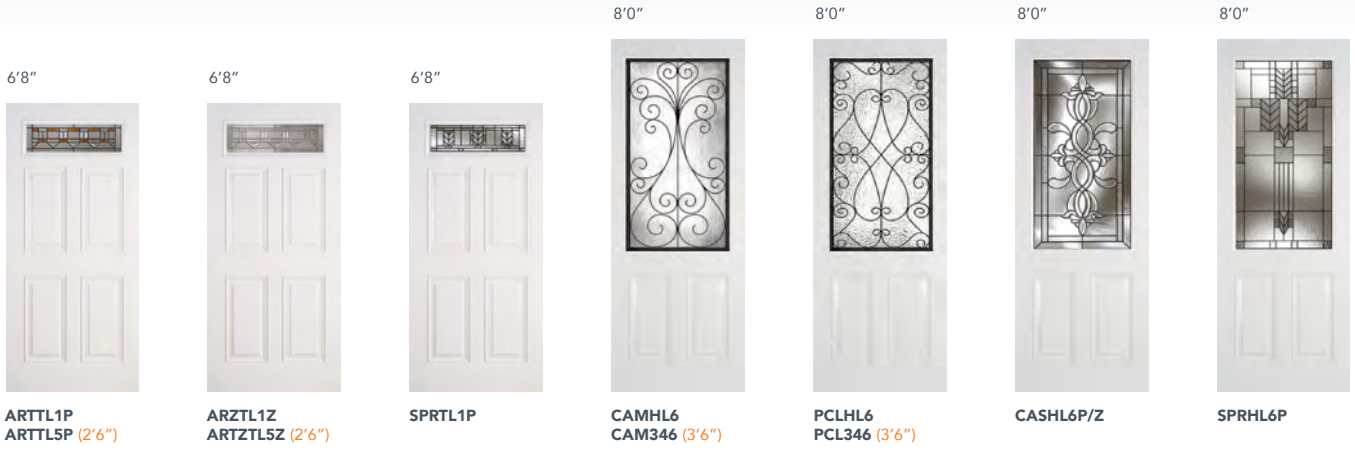

● IN STOCK ● EXTENDED LEAD TIME



SMOOTH SIX PANEL UTILITY DOOR



GLASS OPTIONS

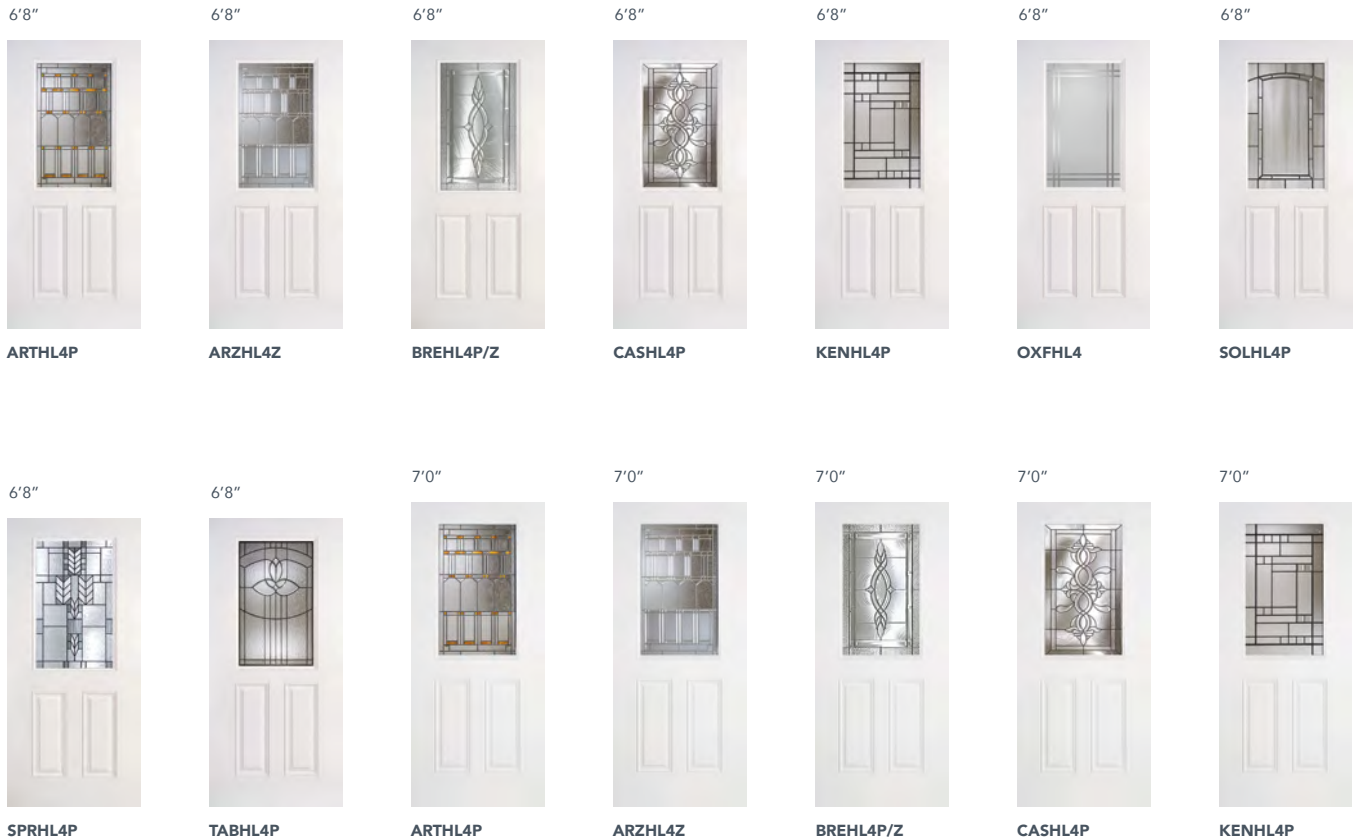

SIX PANEL UTILITY DOOR

7'0"



OXFHL4

7'0"



SOLHL4P

7'0"



SPRHL4P

7'0"

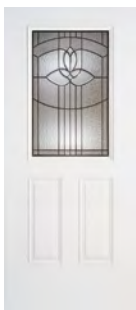

TABHL4P

8'0"

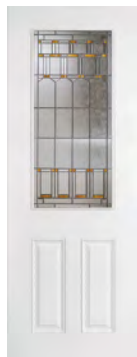

ART342P

8'0"



ARZ342Z

8'0"



BRE342P/Z

8'0"

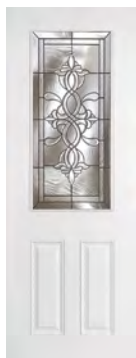

CAS342P

8'0"



KEN342P

8'0"



OXF342

8'0"



SOL342P

8'0"

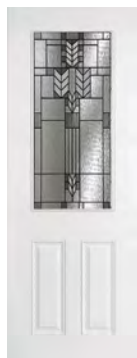

SPR342P

8'0"

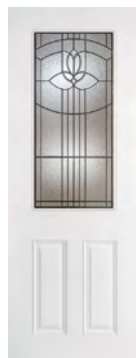

TAB342P

6'8" 7'0"

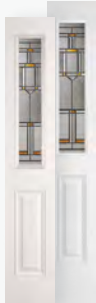

ARTHL2P

6'8" 7'0"



ARZHL2Z

6'8" 7'0"

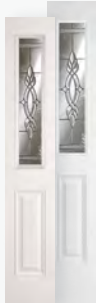

BREHL2P/Z

6'8" 7'0"



CASHL2P

6'8" 7'0"



KENHL2P

6'8" 7'0"



OXFHL2

6'8" 7'0"



SOLHL2P

6'8" 7'0"



SPRHL2P

6'8" 7'0"



TABFL1P

SMOOTH TRUE SIX PANEL NARROW DOOR



GLASS OPTIONS

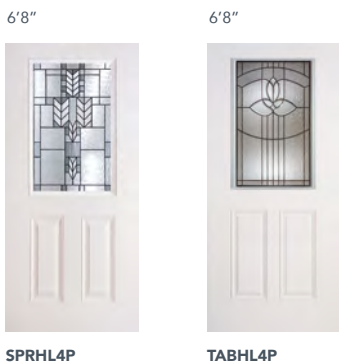

● IN STOCK ● EXTENDED LEAD TIME

TRUE SIX PANEL NARROW DOOR

6'8"



ARTHL2P

6'8"

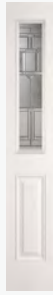

ARZHL2Z

6'8"

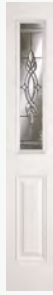

BREHL2ZP/Z

6'8"

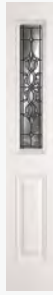

CASHL2ZP

6'8"

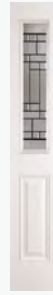

KENHL2P

6'8"

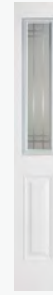

OXFHL2

6'8"

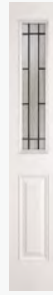

SOLHL2P

6'8"



SPRHL2P

6'8"



TABFL1P

Smooth Series • DRS63 • Glass KENHL4P



SMOOTH EIGHT PANEL DOOR



GLASS OPTIONS

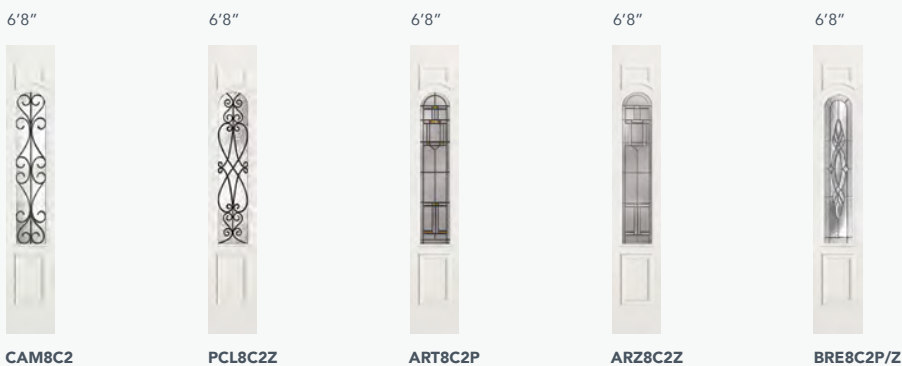

SMOOTH NINE PANEL DOOR

6'8"



2'8" • 3'0"

DR590

GLASS OPTIONS

6'8"



BRE9P1P/Z

6'8"



SPR9P1P

SMOOTH ONE PANEL SHAKER DOOR

SHAKER PROFILE



SHAKER PROFILE

The straightforward shaker design showcases the beauty that minimal design can offer. Our shaker focuses on simplicity and is easily adaptable for any home's exterior.

SMOOTH TWO PANEL SHAKER DOOR

*GLASS OPTIONS VIA SOLUTION FRAME
- SEE PAGE 25 FOR AVAILABLE TEXTURE GLASS STYLES.



22" x 36" HALF LITE
Solution Frame*

● IN STOCK ● EXTENDED LEAD TIME

SMOOTH THREE PANEL CRAFTSMAN DOOR

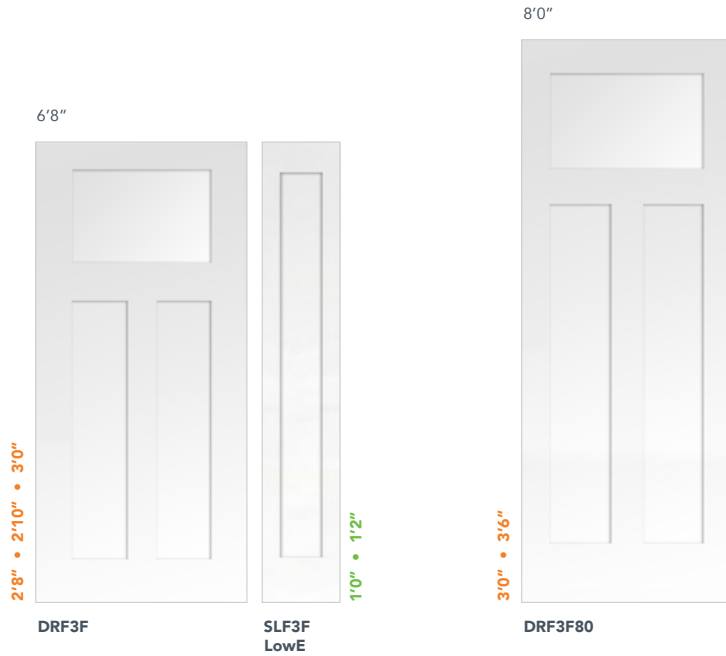

*GLASS OPTIONS VIA SOLUTION FRAME - SEE PAGE 25 FOR AVAILABLE TEXTURE GLASS STYLES.



SMOOTH FIVE PANEL CRAFTSMAN

SHAKER PROFILE



*GLASS OPTIONS VIA SOLUTION FRAME - SEE PAGE 25 FOR AVAILABLE TEXTURE GLASS STYLES.



22"x 8" 1 LITE
5 PANEL
Solution Frame*



22"x 8" 2 LITE
5 PANEL
Solution Frame*





SMOOTH SERIES ACCESSORIES

3 Lite



6'8" ACSDW23005
8'0" ACSDW23001

SIMULATED DIVIDED LIGHTS "SDL" BARS

Plastpro Simulated Divided Lights (SDL Bars) can be used on the interior and exterior of our doors and help create personalized, unique looks. They are easy to install and will not rot or absorb moisture.

6 Lite



6'8" ACSDW23006
8'0" ACSDW23002

Sidelite



ACSDW23004

FEATURES & BENEFITS

- Easy installation using common wood working tools and equipment.
- Will not rot or absorb moisture and resists the growth of fungus and mildew.
- Closed cellular structure prevents paint from peeling off the surface.
- Will not warp or crack when properly installed, or be affected by UV rays when properly coated.



DR53CG000
ACSDW23005
ACDSSW2704

SLF3CG
G000

DR53C80G000
ACSDW23001
ACDSSW2704

SLS3C80
G000

DR53CG000
ACSDW23006
ACDSSW2704

SLS3CG000
ACSDF23004

DR53C80G000
ACSDW23002
ACDSSW2704

SLS3C80G000
ACSDF23004

DR56C
SPRTL3P
ACDSSW2404

ACCESSORIES ARE APPLIED BY PLASTPRO DISTRIBUTORS / DEALERS

Smooth Series • DRS6C • Glass SPRTL3 • Dentil Shelf ACDSSW2716



4 Block Dentil Shelf (DRS3F)



ACDSSW2404

4 Block Dentil Shelf (DRS3C)



ACDSSW2704

16 Block Dentil Shelf



ACDSSW2716

DENTIL SHELF

Plastpro Dentil Shelves are made of lightweight High Density Polyurethane (HDP) and will not warp, rot, or crack. HDP is an excellent alternative to traditional wood products.

FEATURES & BENEFITS

- Recreate Classic Design
- Create Custom Looks
- Affordable

WHITE OAK SERIES



White Oak Series • DRW60



The White Oak Series combines the best features of our Smooth and Oak Doors. Any home can enjoy a rich oak texture pattern in a pre-pigmented white skin. With many choices of decorative glass to choose from, create a look that is both timeless and modern.

DOOR OVERVIEW

<p>6'8"</p>  <p>2'0" • 2'4" • 2'6" • 2'8" • 2'10" • 3'0" • 3'6"</p> <p>DRW00</p>	<p>7'0"</p>  <p>2'0" • 2'4" • 2'6" • 2'8" • 2'10" • 3'0" • 3'6"</p> <p>DRW0070</p>	<p>8'0"</p>  <p>2'0" • 2'4" • 2'6" • 2'8" • 2'10" • 3'0" • 3'6"</p> <p>DRW0080</p>	<p>6'8"</p>  <p>2'8" • 2'10" • 3'0"</p> <p>DRW40</p>	<p>6'8"</p>  <p>2'8" • 3'0"</p> <p>DRW41</p>	<p>6'8"</p>  <p>2'6" • 3'0"</p> <p>DRW60</p>
<p>8'0"</p>  <p>2'6" • 2'8" • 3'0"</p> <p>DRW6080</p>	<p>6'8"</p>  <p>2'8" • 2'10" • 3'0"</p> <p>DRW61</p> <p>🔥</p>	<p>7'0"</p>  <p>2'8" • 2'10" • 3'0"</p> <p>DRW6170</p>	<p>7'0"</p>  <p>2'8" • 2'10" • 3'0"</p> <p>DRW63</p>		

🔥 20 MIN FIRE RATED
 ● IN STOCK
 ● EXTENDED LEAD TIME



White Oak Series • DRW60 • Glass SPRTL1P

WHITE OAK FLUSH PANEL DOOR



GLASS OPTIONS

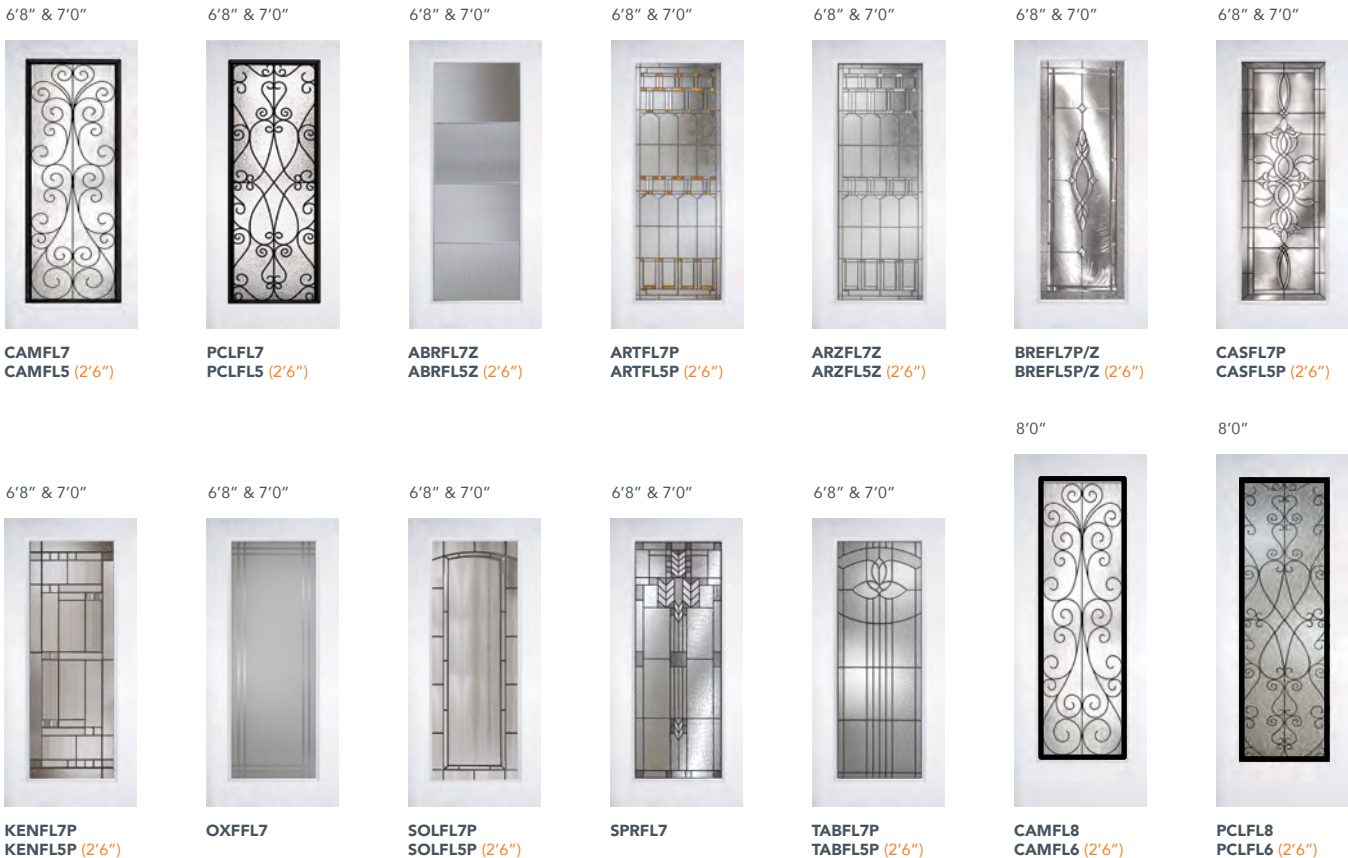

● IN STOCK ● EXTENDED LEAD TIME

WHITE OAK FLUSH PANEL DOOR

8'0"



ABRFL8Z
ABRFL6Z (2'6")

8'0"



ARTFL8P

8'0"



ARZFL8Z

8'0"



BREFL8P/Z

8'0"



CASFL8P

8'0"



KENFL8P

8'0"



OXFFL8

8'0"



SOLFL8P

8'0"



TABFL8P

8'0"



CAMFL1 & FL2

8'0"



PCLFL1 & FL2

8'0"



ABRFL1Z & FL2Z

8'0"



ARTFL1P & FL2P

8'0"



ARZFL1Z & FL2Z

8'0"



BREFL1P/Z & FL2P/Z

8'0"



CASFL1 & FL2

8'0"



KENFLP1 & FL2P

8'0"



OXFFL1 & FL2

8'0"



SOLFL1P & FL2P

8'0"

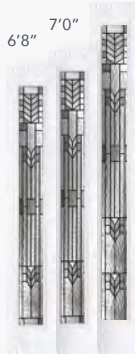

SPRFL1P & FL2P

8'0"

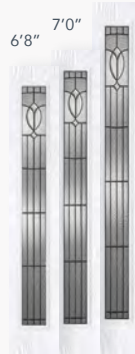

TABFL1P & FL2P

WHITE OAK FOUR PANEL BLANK TOP DOOR



GLASS OPTIONS



CASHR1P

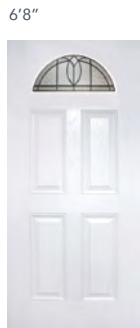

TABHR1P

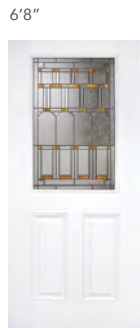

ARTHL4P



ARZHL4Z



BREHL4P/Z



CASHL4P



KENHL4P



OXFHL4



SOLHL4P



SPRHL4P

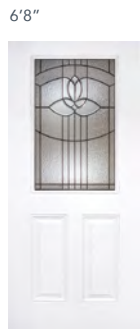

TABHL4P



ARTHL2P



ARZHL2Z



BREHL2P/Z

TRUE WHITE OAK SERIES



FOUR PANEL BLANK TOP DOOR

6'8"



CASHL2P

6'8"



KENHL2P

6'8"



OXFHL2

6'8"



SOLHL2P

6'8"



SPRHL2P

6'8"



TABFL1P



White Oak Series • DRW60

WHITE OAK TRUE FOUR PANEL DOOR

6'8"



2'8" • 3'0"

1'0" • 1'2"

DRW41

SLW60

GLASS OPTIONS

6'8"

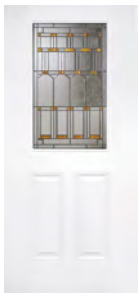

ARTHL4P

6'8"

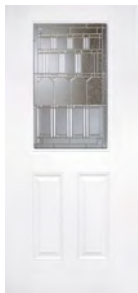

ARZHL4Z

6'8"

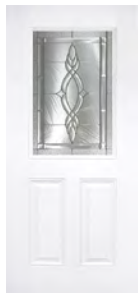

BREHL4P/Z

6'8"

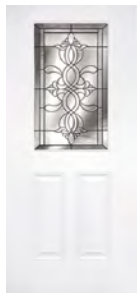

CASHL4P

6'8"



KENHL4P

6'8"



OXFHL4

6'8"



SOLHL4P

6'8"



SPRHL4P

6'8"

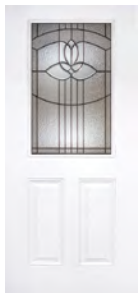

TABHL4P

FOUR PANEL DOOR

6'8"



ARTHL2P

6'8"



ARZHL2Z

6'8"



BREHL2P/Z

6'8"



CASHL2P

6'8"



KENHL2P

6'8"



OXFHL2

6'8"



SOLHL2P

6'8"



SPRHL2P

6'8"



TABFL1P



White Oak Series • DRW00 • Glass ABRFL7



WHITE OAK SIX PANEL DOOR



GLASS OPTIONS

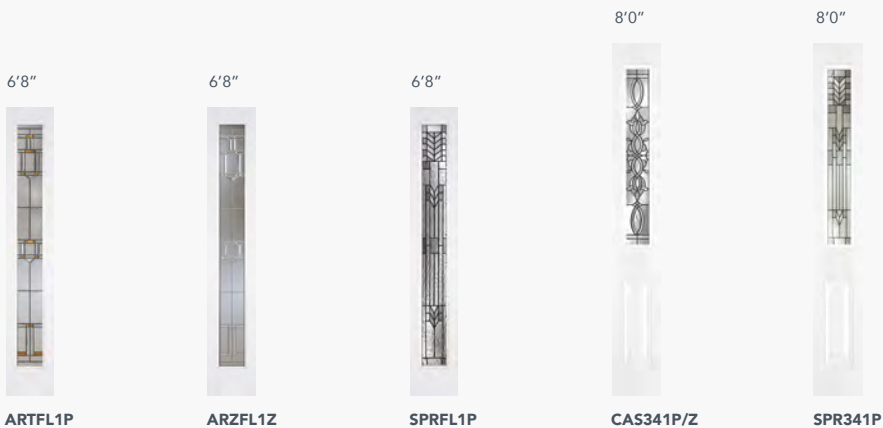
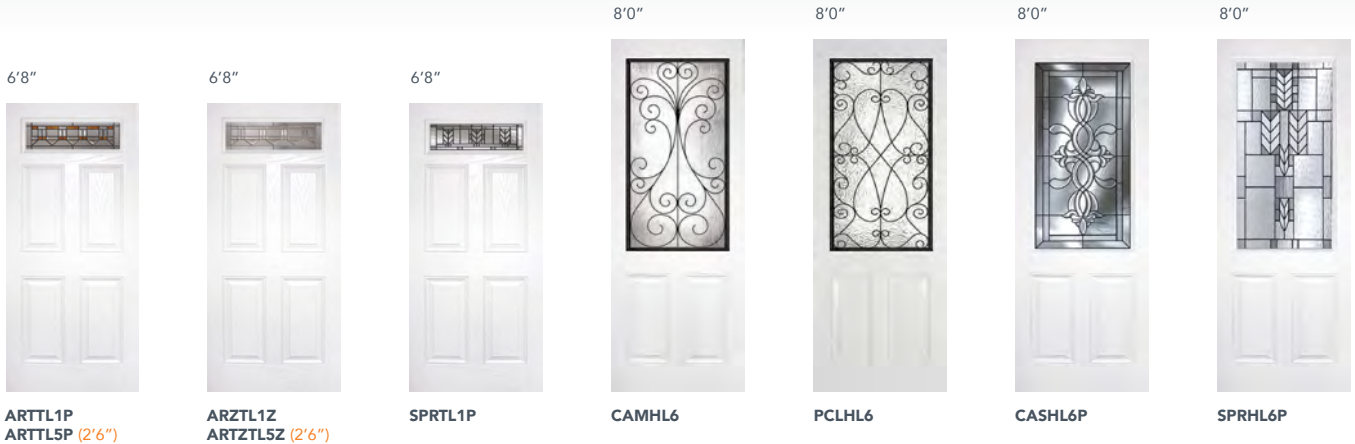

WHITE OAK SIX PANEL UTILITY DOOR



GLASS OPTIONS

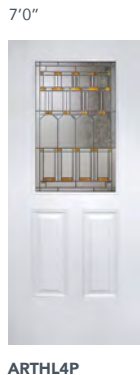
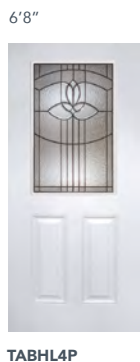
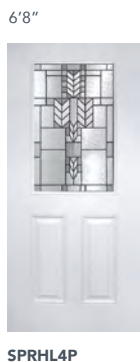
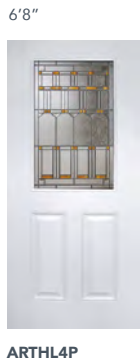

SIX PANEL UTILITY DOOR

7'0"



OXFHL4

7'0"



SOLHL4P

7'0"



SPRHL4P

7'0"

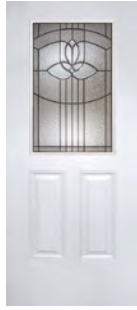

TABHL4P

6'8" 7'0"



ARTHL2P

6'8" 7'0"



ARZHL2Z

6'8" 7'0"



BREHL2P/Z

6'8" 7'0"



CASHL2P

6'8" 7'0"



KENHL2P

6'8" 7'0"



OXFHL2

6'8" 7'0"



SOLHL2P

6'8" 7'0"



SPRHL2P

6'8" 7'0"



TABFL1P



White Oak Series • DRW00 • Glass TABFL7P

WHITE OAK TRUE SIX PANEL NARROW DOOR



GLASS OPTIONS

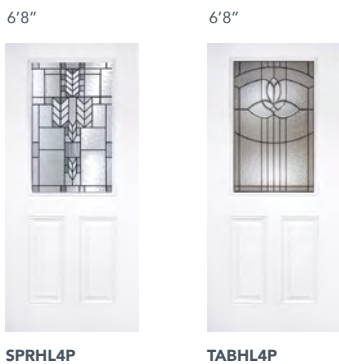

● IN STOCK ● EXTENDED LEAD TIME

SIX PANEL NARROW DOOR

6'8"



ARTHL2P

6'8"



ARZHL2Z

6'8"



BREHL2ZP/Z

6'8"



CASHL2P

6'8"



KENHL2P

6'8"



OXFHL2

6'8"



SOLHL2P

6'8"



SPRHL2P

6'8"



TABFL1P

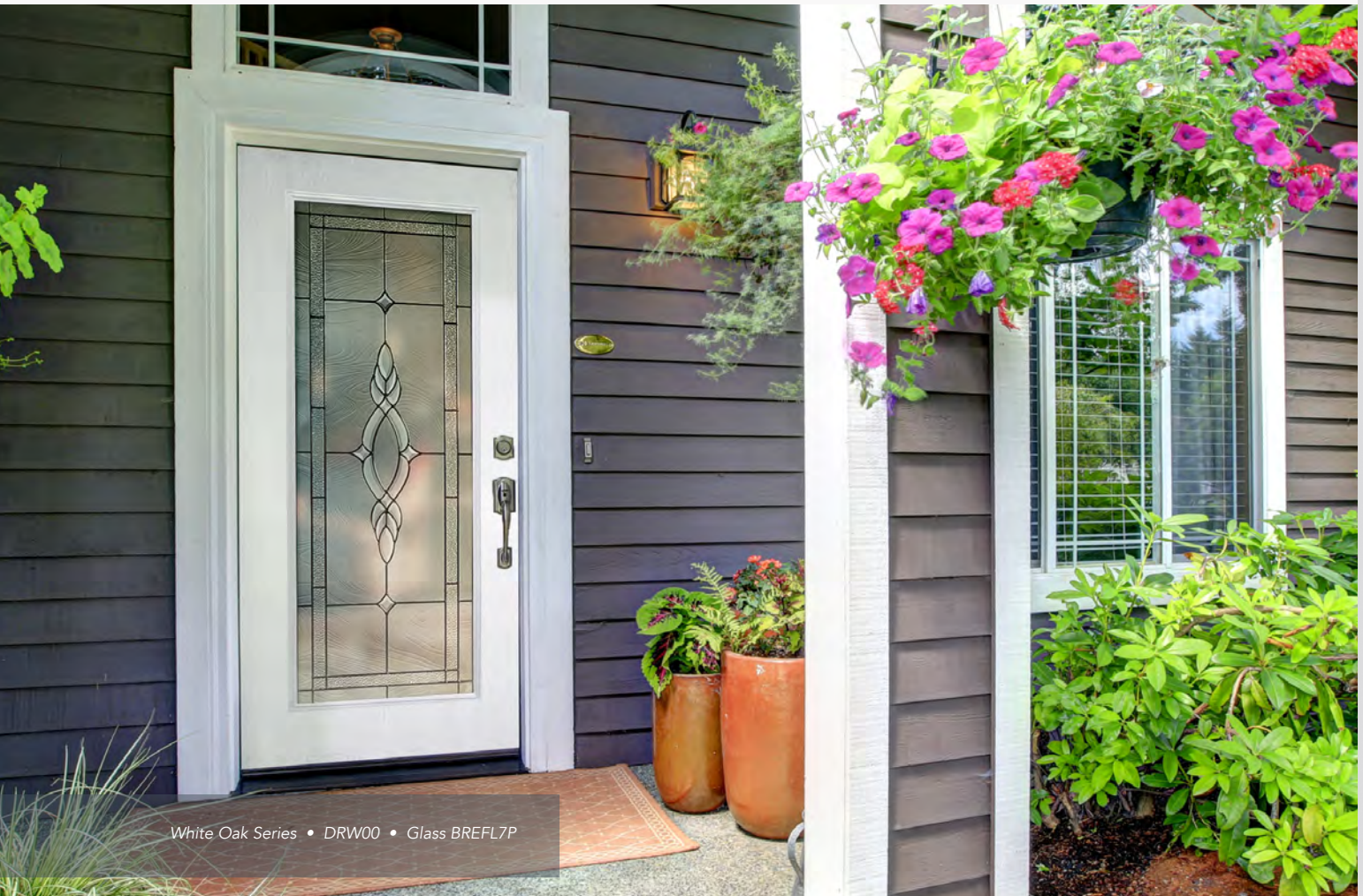

White Oak Series • DRW00 • Glass BREHL2P

ONELITE SERIES

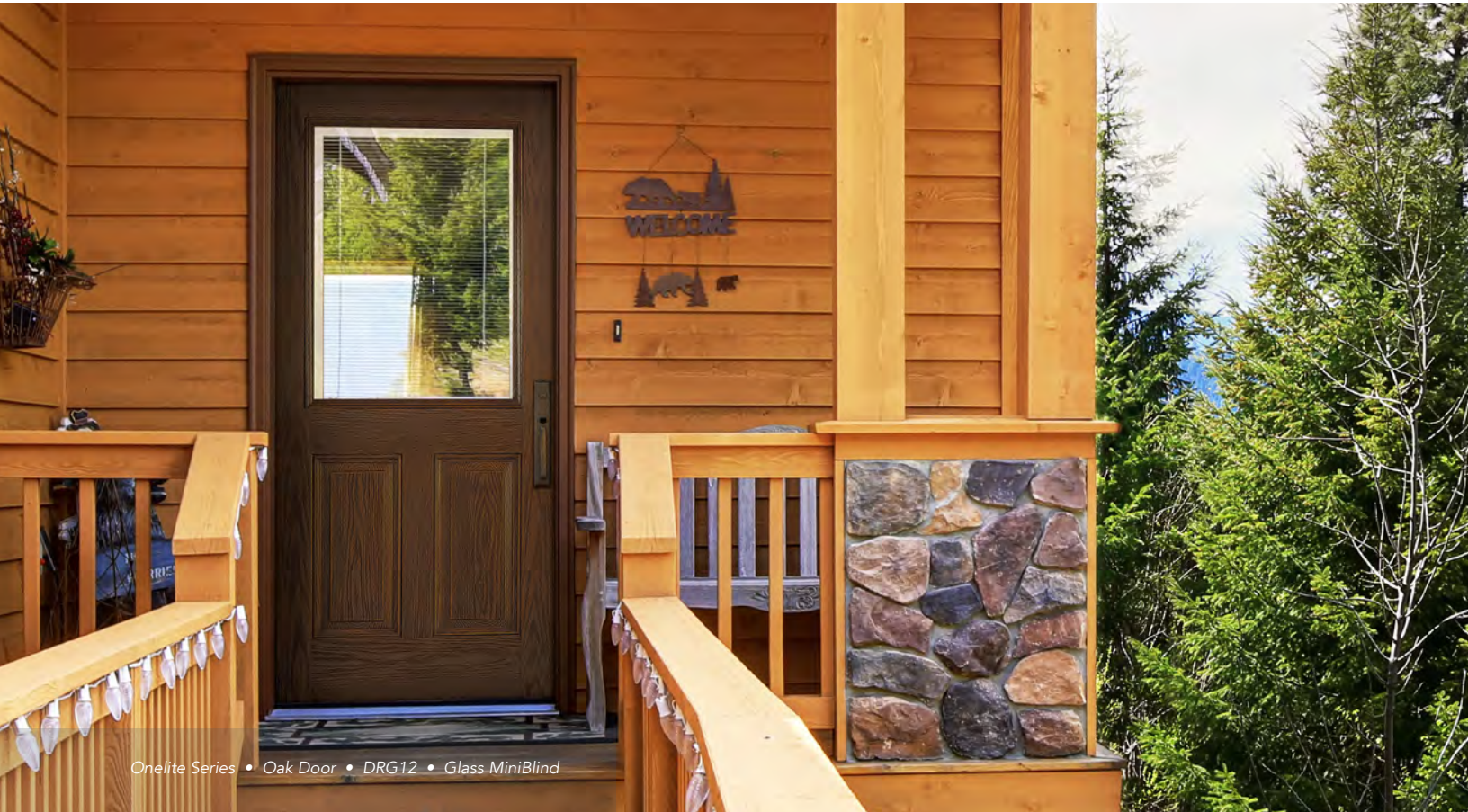

Onelite Series • Oak Door • DRG12 • Glass MiniBlind

OAK GRAIN



SMOOTH FINISH



MAHOGANY GRAIN



Our Onelite Series features a fine, flush glazed glass with a removable stop to allow the glass to be switched without changing the entire door. Doors are available in Double-Insulated Tempered Glass, LowE, Grid Between Glass (GBG), or MiniBlinds.

ALL ONELITE DOORS ARE SHOWN PRE-FINISHED



This model complies with ADA standards and can accommodate ADA required hardware for easy operation. Reinforced blocking and closures allow the following flexible hardware to be installed: panic bars, reinforced arm closures, and exit rim devices. These devices are easy to grasp with one hand and don't require tight grasping or twisting to operate.



SMOOTH ADA DOOR

6'8"



3'0"

DRS11
LowE / Sound Barrier

7'0"



3'0"

DRS1170
LowE / Sound Barrier

8'0"



3'0"

DRS1180
LowE / Sound Barrier

SPECIAL ORDER
Sound Barrier Glass (STC:34) 3'6"
and 4'0" widths

● IN STOCK

● EXTENDED LEAD TIME

FEATURES & BENEFITS

REINFORCED STILES
For Panic Bar hardware
and Exit Rim devices.



6.5" TOP RAIL

Accommodates regular and
parallel arm closer.

5.5" FACE STILES

Accommodates all types
of commercial hardware
(including 2-3/4" backset
161 prep and mortise locks).

ONELITE FLUSH GLAZED HALF LITE DOOR



GLASS OPTIONS



FLUSH GLAZED HALF LITE DOOR



GLASS OPTIONS



● IN STOCK ● EXTENDED LEAD TIME

ONELITE FLUSH GLAZE 3/4 LITE DOOR



GLASS OPTIONS

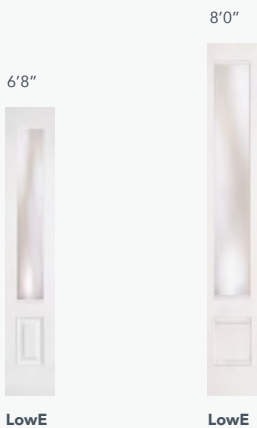

FLUSH GLAZED 3/4 LITE DOOR



GLASS OPTIONS



● IN STOCK ● EXTENDED LEAD TIME

ONELITE SERIES ACCESSORIES



AVAILABLE IN SMOOTH & MAHOGANY

8 & 10 Lite



6'8" ACSDM/S1368L08
8'0" ACSDM/S1380L10

9 Lite

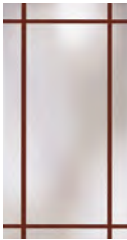

6'8" ACSDM/S1368L09
8'0" ACSDM/S1380L09

SIMULATED DIVIDED LIGHTS "SDL" BARS

Plastpro Simulated Divided Lights (SDL Bars) can be used on the interior and exterior of our doors and help create personalized, unique looks. They are easy to install and will not rot or absorb moisture.

Sidelite



6'8" ACSDM/S1368L02
8'0" ACSDM/S1380L02

FEATURES & BENEFITS

- Easy installation using common wood working tools and equipment.
- Will not rot or absorb moisture, and resists the growth of fungus and mildew.
- Closed cellular structure prevents paint from peeling from the surface.
- Will not warp or crack when properly installed, or be affected by UV rays when properly coated.

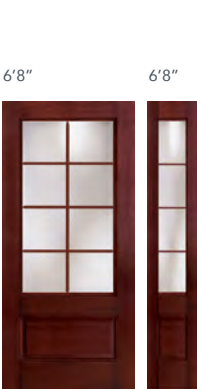

DRM13L ACSDM1368 L08
SLM13L ACSDM1368 L02



DRM1380L ACSDM1380 L10
SLM1380L ACSDM1380 L02



DRM13L ACSDM1368 L09
SLM13L ACSDM1368 L02



DRM1380L ACSDM1380 L09
SLM1380L ACSDM1380 L02

ACCESSORIES ARE APPLIED BY PLASTPRO DISTRIBUTORS/DEALERS

NOVA SERIES

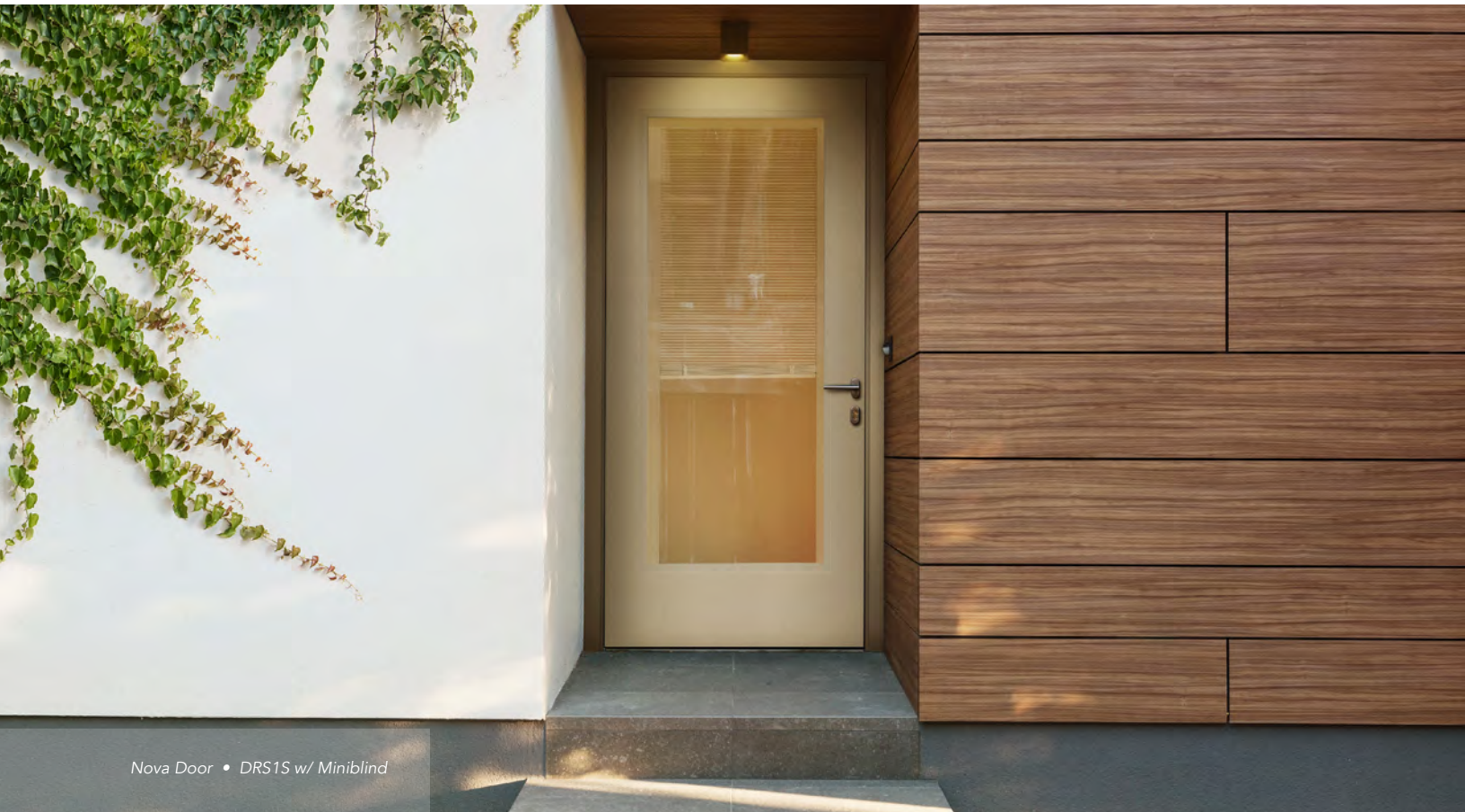

Nova Door • DRS1S w/ Miniblind

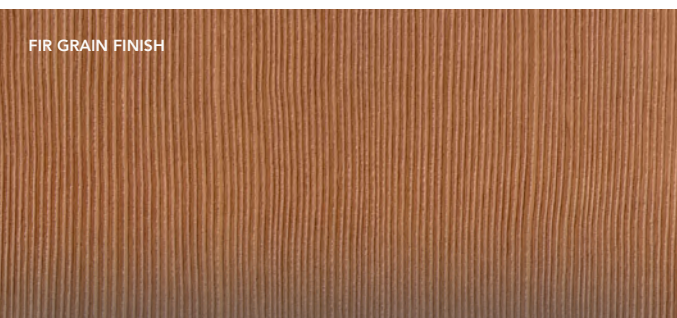

FIR GRAIN FINISH

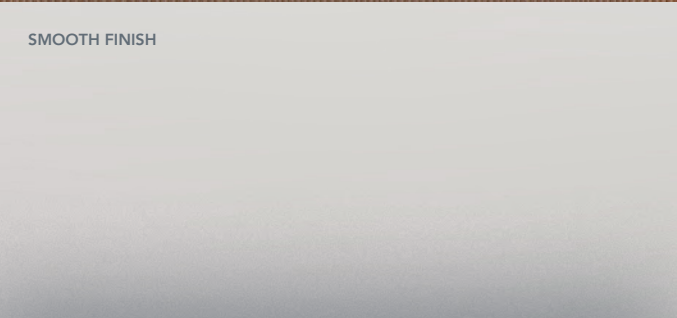

SMOOTH FINISH

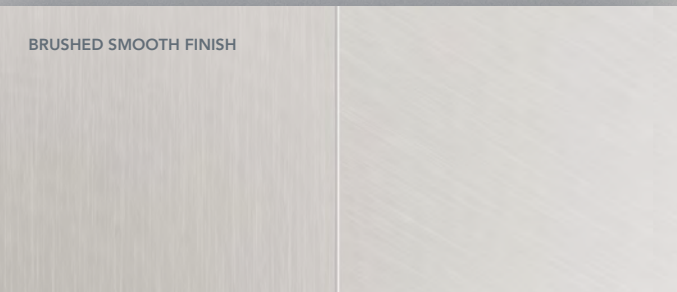

BRUSHED SMOOTH FINISH

The Nova series features glass that is directly glazed into the door to create a seamless blend between the glass and door. The large pane glass allows for the greatest views and amount of light into your home; brightening up the space and filling it with energy. Nova comes in two sticking profiles: craftsman and square. The series is available in both Smooth, Fir and Brushed Smooth Finish.

ALL NOVA SERIES DOORS ARE SHOWN PRE-FINISHED

NOVA 45 SMOOTH FINISH & FIR GRAIN



NOVA 90 BRUSHED SMOOTH FINISH

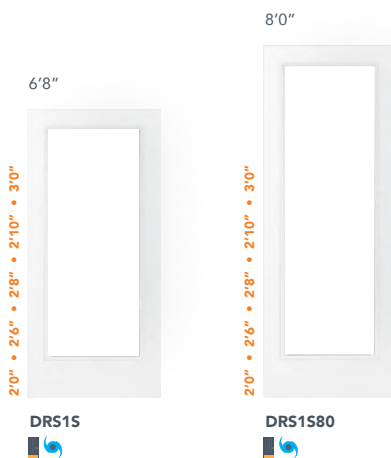

NOVA 45 DIRECT GLAZED

SMOOTH & FIR GRAIN

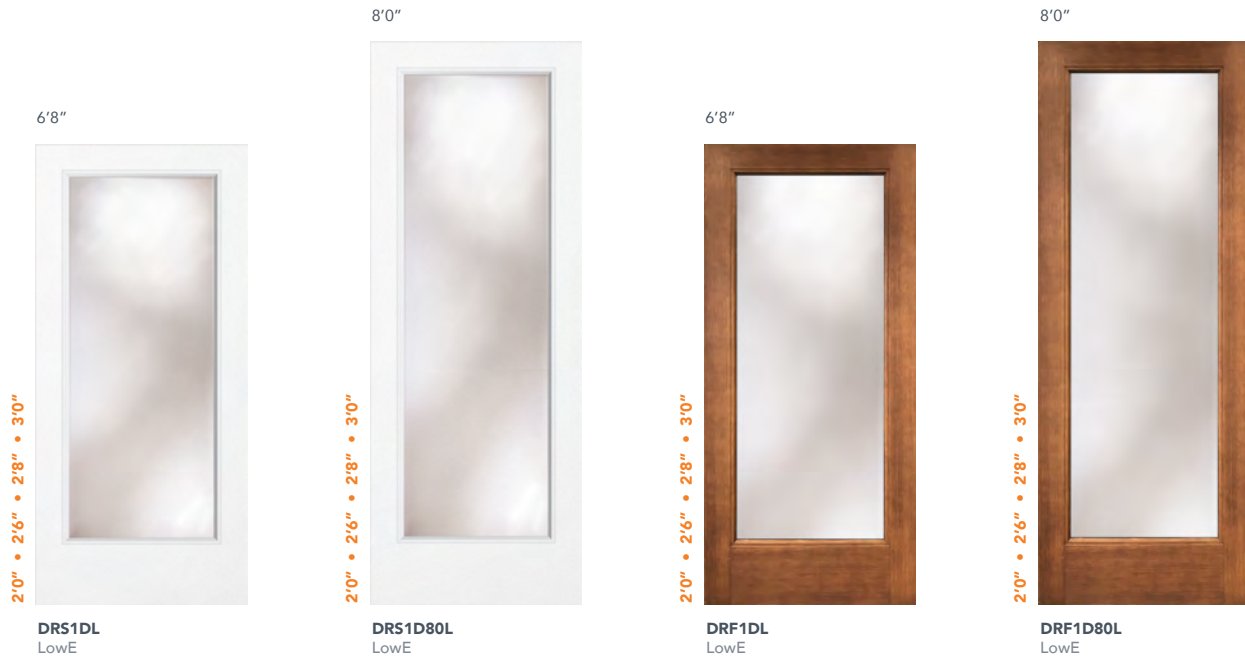

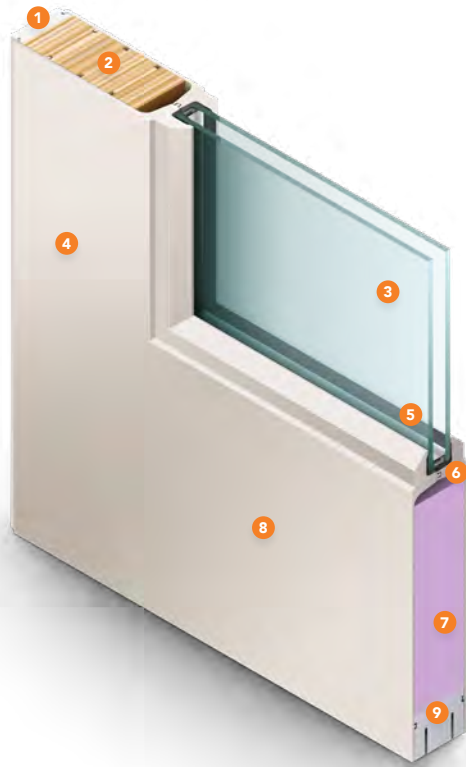

NOVA 45 FEATURES & BENEFITS

- 1 COMPOSITE STILE CAP
- 2 FULL LENGTH LVL (*Hinge & Strike side, for extra rigidity*)
- 3 INSULATED ¾" GLASS (*LoE 272*)
- 4 COMPRESSION MOLDED FIBERGLASS SKIN
- 5 LEAK PROTECTION GLAZING TAPE
- 6 INTEGRALLY MOLDED GLASS STOP
- 7 HIGH INSULATION RIGID FOAM
- 8 ADA COMPLIANT BOTTOM RAIL
- 9 COMPOSITE BOTTOM RAIL



Nova Door • DRE1DL • Clear LowE

NOVA 90 DIRECT GLAZED

BRUSHED SMOOTH FINISH

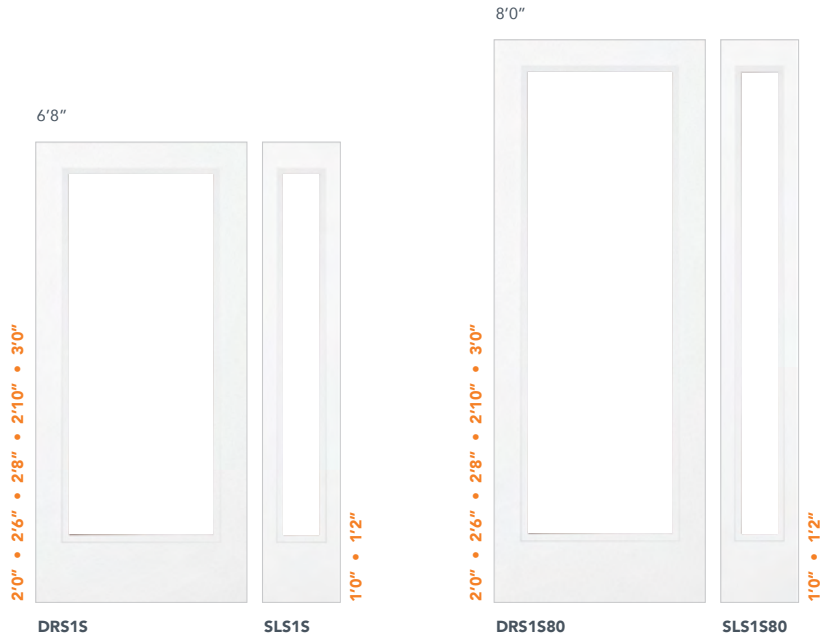

GLASS OPTIONS

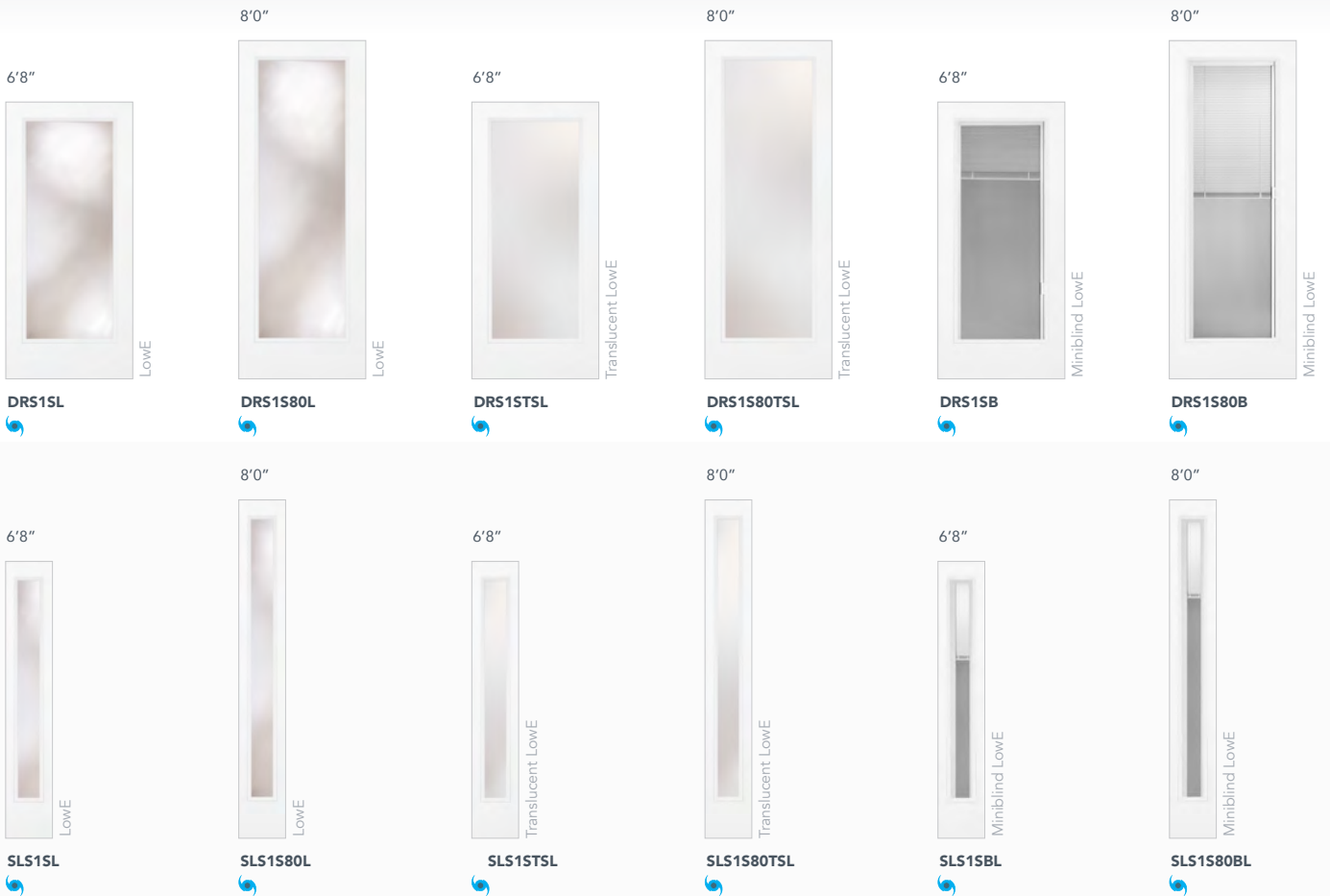

HVHZ IMPACT AVAILABLE IN STOCK EXTENDED LEAD TIME

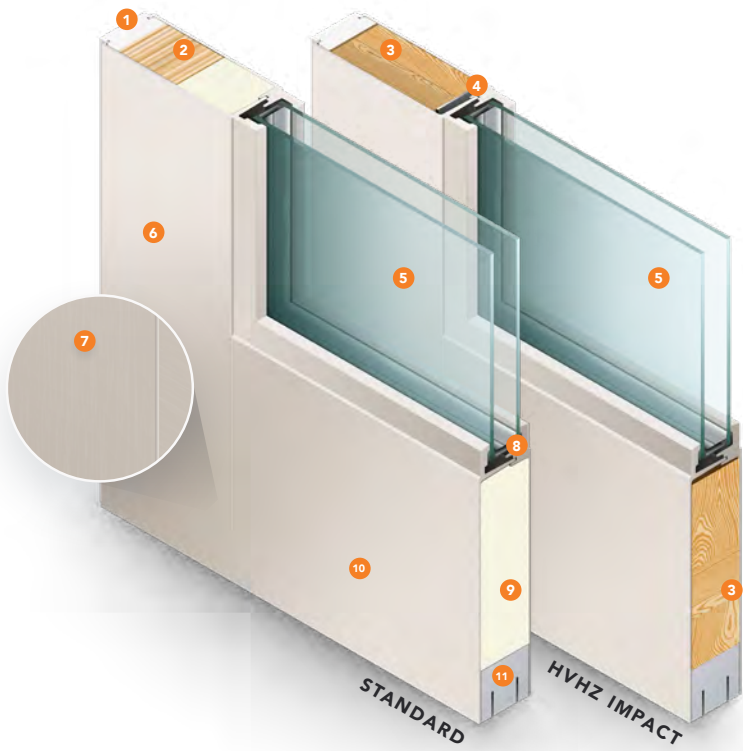

FEATURES & BENEFITS

- 1 COMPOSITE STILE CAP
- 2 FULL LENGTH LVL (*Hinge & Strike side, for extra rigidity*)
- 3 WOOD BLOCKING (*For structural support*)
- 4 STEEL BEAM (*Hinge & Strike side, for extra rigidity*)
- 5 INSULATED 1" GLASS
- 6 COMPRESSION MOLDED FIBERGLASS SKIN
- 7 BRUSH FINISHED TEXTURE
- 8 INTEGRALLY MOLDED GLASS STOP
- 9 HIGH DENSITY POLYURETHANE FOAM
- 10 ADA COMPLIANT BOTTOM RAIL
- 11 COMPOSITE BOTTOM RAIL



Nova Series • DRS1SB • Miniblind LowE

STAIN KIT & STAINING GUIDES

Plastpro Stain Kit is an easy way to stain your fiberglass door exactly how you want for you home.

We've created easy step-by-step directions using our stain kit to make staining your door a breeze. These staining instructions were created for staining our oak, rustic, fir, cherry, and mahogany skin series.

Our kit is designed exclusively for Plastpro fiberglass entry doors.



STAIN KIT

Plastpro Stain Kit contains everything you need to stain one prehung door and two sidelites, or one double door unit.

BENEFITS & ADVANTAGES

- Protects the door from the sun, UV rays, and harsh winter weather.
- Faster drying time with environmentally friendly water based top coat. Easy to apply
- Special formula with long lasting vibrant colors.

BOX CONTAINS

- Zar® Exterior Water Base Polyurethane (qt)
- Zar® Wood Stain (pt)
- Mineral Spirits (4 oz.)
- Two 2" Foam Brushes
- One 2.5" Synthetic Bristle Brush
- Cheese Cloths
- Two Stir Sticks
- One Pair of Latex Gloves
- Door Staining Instructions
- Two Skin Samples

LIMITED
5-YEAR
FINISH
WARRANTY

STAIN COLOR OPTIONS

The kit comes in seven different stain variations. Depending on your desired shade, you may need to apply the stain more than once for a darker finish. *Actual stain color may vary. To achieve the best results, test on the skin sample first.

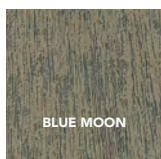

BLUE MOON

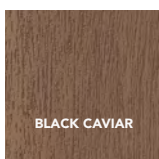

BLACK CAVIAR

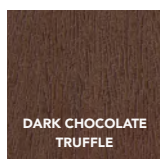

DARK CHOCOLATE
TRUFFLE

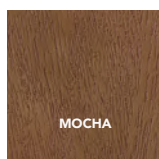

MOCHA

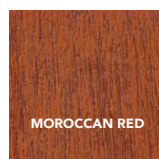

MOROCCAN RED

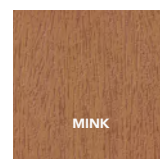

MINK



CHAMPAGNE

Colors shown have one coat of stain.

MATERIALS NEEDED

PLASTPRO'S PRE-FINISH KIT OR:

- | | |
|---------------------------------|---------------------------|
| A. Pre-Mixed Stain (1/2 pint) | F. 3" China Bristle Brush |
| B. Mineral Spirits (4 fl. oz.) | G. Two Stir Sticks |
| C. Top Coat/Sealer (20 fl. oz.) | H. Two Skin Samples |
| D. Two Clean Cloth | I. Finishing Instruction |
| E. One Pair Protective Gloves | |

STAINING INSTRUCTIONS FOR GRAINED DOORS & PFT™ DOOR FRAMES

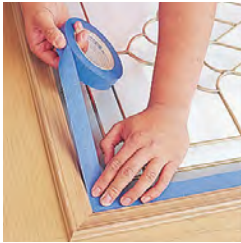

STEP 1: SURFACE PREPARATION

1. Lay door horizontally on saw horses or a table.
2. Remove all the hardware and mask off anything you don't want stained such as the glass insert.
3. DO NOT SAND GRAINED FIBERGLASS / PFT™ DOOR FRAMES
4. Wipe the Door / PFT™ Door Frame with mineral spirits to clean any dust or residue from the surface. Allow door surface to dry completely before applying stain.



STEP 2: STAIN APPLICATION

1. Starting at the center of the Door / PFT™ Door Frame, stain one to two panels at a time. Apply stain with a 3" to 4" soft bristle brush, or rag. Apply enough stain to fill the Door / PFT™ Door Frame grain.
2. With a clean, lint free 24" x 24" cloth, softly wipe the surface until you reach your desired tone. TIP: When the rag becomes saturated with stain, refold to work with a less saturated section. Be sure to use the same rag for the whole Door / PFT™ Door Frame.
3. After all stain is brushed evenly, you may add finishing touches by using a small 1" to 2" brush or cotton swabs.
4. (If desired) Allow the Door / PFT™ Door Frame to dry for at least 48 hours before applying another coat. Then, repeat above process.

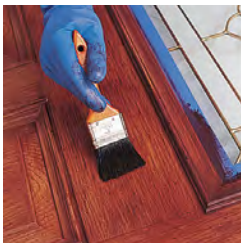

STEP 3: PROTECTIVE TOP COAT

Application of polyurethane top coat with UV inhibitors like ZAR™ Exterior polyurethane, Wood Kote® Flagship UV, or Minwax® Fast Drying Polyurethane for exterior applications.

1. After stain has completely dried (48 hours), mix the top coat well and apply evenly using a clean dry 2" soft bristle brush or 3" foam brush. Be sure to stop when the grain changes direction.
2. Apply two or three coats of finish, allowing at least 24 hours of drying time between each application.

IMPORTANT TO NOTE:

- It is considered normal maintenance to re-apply the topcoat approximately every two years. Even a well-finished fiberglass door will be affected by exposure and weathering from sun, moisture, and air pollutants.
- Staining instructions are for Oil-Based, Premium Quality Wood Stains or similar product designed for use on a fiberglass surface. Please note the instructions indicated are specific to the Zar brand stain included in our stain kit. Please reference stain manufacturers instructions before applying any stain.

MATERIALS NEEDED

- | | |
|--------------------|--|
| A. Lint-free cloth | E. 4" Bristle Brush |
| B. Mineral Spirits | F. For Water-based Application: Acrylic-based primer*/ acrylic latex-based exterior grade paint. |
| C. Rubber gloves | |
| D. Masking tape | |

We recommend using Sherwin-Williams PrepRite® Bonding Primer with compatible acrylic-latex paint for optimal paint adhesion.

PAINTING INSTRUCTIONS FOR OAK GRAIN DOORS



STEP 1: SURFACE PREPARATION

1. Lay door horizontally on saw horses or a table.
2. Remove all the hardware and mask off anything you don't want painted, such as the glass insert.
3. DO NOT SAND GRAINED FIBERGLASS.
4. Wipe the door with mineral spirits to clean any dust or residue from the surface. Allow door surface to dry completely before applying stain paint. Do not use hydro-carbon based solvents to clean the surface as such products may leave a residue.
5. Apply primer with a 4" brush beginning with the panels. Follow the manufacturer's instructions for drying time before applying topcoat. Continue to apply the primer to ALL 6 sides. Doors which have been bored and mortised for hardware should be primed inside of the lock bore as well.
6. The primer must be completely dry before applying the topcoat.



STEP 2: PAINTING

1. Apply exterior grade paint with 4" brush beginning with the panels.
2. It is common practice to paint both stiles the same color as the exterior side of the door. If applying a second coat, follow the manufacturer's instructions for drying time between coats.
3. Continue to apply the top coat to ALL 6 sides of the door which have been bored and mortised for hardware should be finished inside of the lock bore as well.

CAUTION

1. When using stains, mineral spirits, paints, or other hazardous materials, always read and follow the manufacturer's instructions. Plastpro, Inc. makes no representations as to the proper use of other manufacturers' products.
2. When working with paints or solvents, make sure the working area is well ventilated.
3. Keep away from heat and flame as materials may be combustible.
4. Paints or solvents may cause skin and eye irritation. Avoid contact with skin and eyes.
5. Keep out of reach of children.

IMPORTANT TO NOTE:

- It is considered normal maintenance to re-apply the topcoat approximately every two years. Even a well-finished fiberglass door will be affected by exposure and weathering from sun, moisture, and air pollutants.

MATERIALS NEEDED

- A. Lint-free Cloth
- B. Mineral Spirits
- C. Rubber Gloves
- D. Masking Tape
- E. 4" Bristle Brush

F. For Water-based Application: Acrylic-based primer* / acrylic latex-based exterior grade paint.

G. Scotch Brite Pad (Fine) or 320-400 grit sandpaper
(For Smooth Doors Only)

We recommend using Sherwin-Williams PrepRite® Bonding Primer with compatible acrylic-latex paint for optimal paint adhesion.

PAINTING INSTRUCTIONS FOR DOORS & PF™ DOOR FRAMES



STEP 1: SURFACE PREPARATION

1. Lay door horizontally on saw horses or a table.
2. Remove all the hardware and mask off anything you don't want painted, such as the glass insert.
3. **Smooth Doors only.** Lightly scuff sand the surface with a Scotch Brite pad or fine sand paper. **DO NOT SAND GRAINED FIBERGLASS.**
4. Wipe the door with mineral spirits to clean any dust or residue from the surface. Allow acetone to dry from the surface before applying.
5. Do not use hydro-carbon based solvents to clean the surface as such products may leave a residue.
6. Apply primer with a 4" brush beginning with the panels. Follow the manufacturer's instructions for drying time before applying topcoat. Continue to apply the prime to ALL 6 sides. Doors / PF™ Door Frames which have been bored and mortised, or machined for hardware should be primed inside of the lock bore, or prepped area as well.
7. The primer must be completely dry before applying the topcoat.



STEP 2: PAINTING

1. Apply exterior grade paint with 4" brush beginning with the panels.
2. It is a common practice to paint both door stiles, or both PF™ Door Frame sides, the same color as the exterior side of the door. If applying a second coat, follow the manufacturer's instructions for drying time between coats.
3. Continue to apply the top coat to ALL 6 sides of the door which have been bored and mortised for hardware should be finished inside of the lock bore as well.

CAUTION

1. When using stains, mineral spirits, paints, or other hazardous materials, always read and follow the manufacturer's instructions. Plastpro Inc. makes no representations as to the proper use of other manufacturers' products.
2. When working with paints or solvents, make sure the working area is well ventilated.
3. Keep away from heat and flame as materials may be combustible.
4. Paints or solvents may cause skin and eye irritation. Avoid contact with skin and eyes.
5. Keep out of reach of children.

IMPORTANT TO NOTE:

- It is considered normal maintenance to re-apply the topcoat approximately every two years. Even a well-finished fiberglass door will be affected by exposure and weathering from sun, moisture, and air pollutants.

TESTING RESULTS

ASTM D1761	Screw holding capacity.
NWWDA TM-7	Cycle slam test.
NWWDA TM-8	Hinge load resistance test.
ASTM E 283	Air infiltration.
ASTM E 331 / E 547	Water resistant.
ASTM E 330	Uniform structural load.
ASTM E1886 / E1996	Impact / cycle test.
AAMA 1304	Forced entry resistance test.
TAS 201	Impact test.
TAS 202	Air / water / structural test.
TAS 203	Wind pressure cycle test.
NFRC 100 / 200 / 500	Energy efficiency.
ASTEM E90 / STC / OITC	Sound transmission.
ULC 10 C / NFPA 252 / ASTM E 2074	Fire rated.
CDPH / EHLB METHOD V1.1 2010	Volatile organic chemical emission test.
JIS Z 2801:2001	Antimicrobial products test.
ASTM D1413-07	Antifungal wood plastic composite test.
CSFM 12-7A-1	Exterior wildfire exposure test.
AAMA 1702	Exterior door test for manufactured housing.
AAMA 920	Operating cycle test.
AAMA / WDMA / CSA 101 / I.S./A440 (NAFS)	North America fenestration test.

The PLASTPRO DOOR met requirements for sawing, planing, routing, boring, drilling and chiseling. For more specific results, please see our website at www.plastproinc.com or contact our Customer Service Department at 1 (800) 779-0561.



WARNING: These products may include styrene, titanium dioxide and wood dust, which are known to the State of California to cause cancer. For more information go to www.p65warnings.ca.gov

PRODUCT INDEX

Easily locate Plastpro Doors, PF™ Door Frames and accessories within the catalog.

PG 177 - 182

PFT™ DOOR FRAMES

CATEGORY	NAME	AVAILABLE GRAINS	PAGE
DOOR FRAME	4-9/16" Door Frame	Oak Grain, Fir Grain, Mahogany, Primed, White Capped	7 - 9
	5-1/4" Door Frame	Primed, White Capped	7 - 9
	6-9/16" Door Frame	Oak Grain, Fir Grain, Mahogany, Primed, White Capped	7 - 9
	7-1/4" Door Frame	Primed, White Capped	7 - 9
	WM180 Florida Brickmold	Oak Grain, Fir Grain, Mahogany, Primed, White Capped	7 - 9
	WM176 Brickmold	Oak Grain, Primed	7 - 9
	1-1/2" x 1" Mull Post Cover	Oak Grain, Fir Grain, Mahogany, Primed, White Capped	7 - 9
	2" x 1" Mull Post Cover	Oak Grain, Fir Grain, Mahogany, Primed, White Capped	7 - 9
	Mull Post Cap	Oak Grain, PVC - White	7 - 9
	Mull Post w/ LVL-3P	Oak Grain, Fir Grain, Mahogany, Primed, White Capped	7 - 9
	1" x 2" Stuccomold	Primed	7 - 9
	6'8" & 8'0" Astragal	PVC - White	7 - 9
	.551" x 8'4" Sidelite Stopper	Oak Grain, Primed	7 - 9
	Nailing Fin	Oak Grain, Primed, White Capped	7 - 9
	J-Channel	Oak Grain, Primed, White Capped	7 - 9
	Flat casing	Oak Grain, Primed, White Capped	7 - 9
	Flat Casing J-Channel	Oak Grain, Primed, White Capped	7 - 9
	Trim Boards	PVC - White	7 - 9
	1-1/4" x 3" Jamb Extension	Oak Grain, Fir Grain, Mahogany, Primed, White Capped	7 - 9
	1" x 2-1/2" Storm Door Adapter	Oak Grain, Fir Grain, Mahogany, Primed, White Capped	7 - 9
	1" x 3" Storm Door Adapter	Oak Grain, Fir Grain, Mahogany, Primed, White Capped	7 - 9
	4-9/16" Transom Sill	Oak Grain, Fir Grain, Mahogany, Primed, White Capped	7 - 9
	6-9/16" Transom Sill	Oak Grain, Fir Grain, Mahogany, Primed, White Capped	7 - 9
	PFT™ Arch & Radius Headers	Oak Grain	7 - 9

FIBERGLASS ENTRY SYSTEMS

SERIES	CODE	HEIGHT	WIDTH	DESCRIPTION	PAGE
LIMITED	DRC21	6'8"	3'0"	Two Panel	30 - 31
	DMT51	6'8"	2'8", 2'10", 3'0", 3'6"	Modern Teak Milan Door	32
	DMT5170	7'0"	3'0", 3'6"	Modern Teak Milan Door	32
	DRK2B	6'8"	2'8", 2'10", 3'0"	Two Panel	33
MODERN	DMG46	6'8"	2'6", 2'8", 2'10", 3'0", 3'6"	South Beach, Oak Grain	36
	DMG4680	8'0"	2'6", 2'8", 2'10", 3'0", 3'6"	South Beach, Oak Grain	36
	DMG51	6'8"	2'6", 2'8", 2'10", 3'0"	Napoli, Oak Grain	36
	DMG5180	8'0"	2'6", 2'8", 2'10", 3'0"	Napoli, Oak Grain	36
	DMS1L	6'8"	2'6", 2'8", 2'10", 3'0", 3'6"	Bienvenue Left Lite, Smooth Skin	37
	DMS1L80	8'0"	3'0", 3'6"	Bienvenue Left Lite, Smooth Skin	37
	DMS1R	6'8"	2'6", 2'8", 2'10", 3'0", 3'6"	Bienvenue Right Lite, Smooth Skin	38
	DMS1R80	8'0"	3'0", 3'6"	Bienvenue Right Lite, Smooth Skin	38
	DMS1T	6'8"	2'6", 2'8", 2'10", 3'0", 3'6"	Martinique Twin Lite, Smooth Skin	39
	DMS1T80	8'0"	3'0", 3'6"	Martinique Twin Lite, Smooth Skin	39
	DMS3HI	6'8"	2'6", 2'8", 2'10", 3'0"	Empire, Smooth Skin	40

SERIES	CODE	HEIGHT	WIDTH	DESCRIPTION	PAGE
MODERN	DMS3H80I	8'0"	2'6", 2'8", 2'10", 3'0"	Empire, Smooth Skin	40
	DMS5HI	6'8"	2'6", 2'8", 2'10", 3'0"	Infinity, Smooth Skin	40
	DMS5H80I	8'0"	2'6", 2'8", 2'10", 3'0"	Infinity, Smooth Skin	40
RUSTIC	DRATP	6'8"	2'6", 3'0", 3'6"	True Plank, Square Top	44
	DRATP70	7'0"	3'0"	True Plank, Square Top	44
	DRATP80	8'0"	2'6", 3'0", 3'6"	True Plank, Square Top	44
	DRA1A80	8'0"	3'0", 3'6"	One Panel, Arch Plank	44
	DRA1P	6'8"	3'0"	One Panel, Square Plank	45
	DRA1P80	8'0"	3'0", 3'6"	One Panel, Square Plank	45
	DRA2A	6'8"	3'0"	Two Panel, Arch Plank	46
	DRA2A80	8'0"	3'0", 3'6"	Two Panel, Arch Plank	46
	DRA2B	6'8"	3'0"	Two Panel, Square Panel	47
	DRA2C	6'8"	3'0"	Two Panel, Arch Plank, Arch Top	48
	DRA2C80	8'0"	3'0", 3'6"	Two Panel, Arch Plank, Arch Top	48
	DRA2D	6'8"	3'0", 3'6"	Two Panel, Arch Panel	49
	DRA2F80	8'0"	3'0"	Two Panel, Radius Panel, Radius Top	50
	DRA2P80	8'0"	3'0", 3'6"	Two Panel, Square Plank	50
	DRA2R80	8'0"	3'0"	Two Panel, Radius Panel	51
	DRA4R80	8'0"	3'0", 3'6"	Four Panel, Radius Panel	51
	ACCLP12Q	1 1/2"	1 1/2"	Square Clavos	52
	ACCLP14Q	1 1/4"	1 1/4"	Square Clavos	52
	ACCLP12R	1 1/2"	1 1/2"	Round Clavos	52
	ACCLP14R	1 1/4"	1 1/4"	Round Clavos	52
	ACCHGSTP18	2 1/9"	18"	Wrought Iron Hinge Strap	53
ACCSPKY0910KIT	15 1/4"	8 3/4"	Wrought Iron Speakeasy	53	
ACCSPKYGSB0KIT	11 8/9"	9 8/9"	Wrought Iron Speakeasy	53	
MAHOGANY	DRM3D	6'8"	3'0"	Three Panel Deluxe	56
	DRM4E	6'8"	3'0"	Four Panel Eyebrow	57
	DRM40	6'8"	2'6", 2'8", 2'10", 3'0"	Four Panel Blank Top	58 - 60
	DRM41	6'8"	3'6"	True Four Panel	60
	DRM60	6'8"	3'0"	Six Panel	61
	DRM6080	8'0"	3'6"	Six Panel	61
FIR GRAIN	DRF3C	6'8"	3'0"	Direct Glazed Craftsman	64 - 65
	DRF3C80	8'0"	3'0"	Direct Glazed Craftsman	64 - 65
	DRF1K	6'8"	2'8", 2'10", 3'0"	One Panel Square Top Shaker	66
	DRF2K	6'8"	2'8", 2'10", 3'0"	Two Panel Square Top Shaker	66
	DRF3F	6'8"	2'8", 2'10", 3'0"	Three Panel Shaker Craftsman	67
	DRF3F80	8'0"	3'0"	Three Panel Shaker Craftsman	67
	DRF50	6'8"	2'8", 2'10", 3'0"	Five Panel Shaker Craftsman	68
	ACDSFT2704	3 5/8"	27"	4 Block Dentil Shelf (DRF3C)	69
	ASDSFT2404	3 5/8"	24"	4 Block Dentil Shelf (DRF3F)	69
	ACSDF23001	1 1/2"	17 1/8" (4 pcs)	3-Lite SDL Bars for 6'8" Door	69
	ACSDF23005	1 1/2"	23" (4 pcs)	3-Lite SDL Bars for 8'0" Door	69
	ACSDF23002	1 1/2"	25 3/4" (2 pcs), 8 21/32" (8 pcs)	6-Lite SDL Bars for 6'8" Door	69
	ACSDF23006	1 1/2"	26" (2 pcs), 11 3/16" (8 pcs)	6-Lite SDL Bars for 8'0" Door	69

SERIES	CODE	HEIGHT	WIDTH	DESCRIPTION	PAGE
FIR GRAIN	ACSD23004	1 1/2"	8 3/4" (2 pcs)	2-Lite SDL Bars for 6'8" and 8'0" Sidelite	69
OAK GRAIN	DRG00	6'8"	2'0", 2'4" 2'6", 2'8", 2'10", 3'0", 3'6"	Flush	72 - 74
	DRG0070	7'0"	2'0", 2'4" 2'6", 2'8", 2'10", 3'0", 3'6"	Flush	72 - 74
	DRG0080	8'0"	2'0", 2'4" 2'6", 2'8", 2'10", 3'0", 3'6"	Flush	72 - 74
	DRG20	6'8"	3'0"	3/4 Heritage	75
	DRG29	6'8"	2'8", 2'10", 3'0"	3/4 Two Panel	76 - 77
	DRG2980	8'0"	2'8", 2'10", 3'0"	3/4 Two Panel	76 - 77
	DRG3E	6'8"	3'0"	3/4 Elite	78
	DRG3P	6'8"	3'0"	3/4 Premium	79
	DRG3080	8'0"	2'8", 3'0", 3'6"	3/4 Three Panel	80 - 81
	DRG31	6'8"	3'0"	Three Panel	81
	DRG3170	7'0"	3'0"	Three Panel	81
	DRG40	6'8"	2'6", 2'8", 2'10", 3'0"	Four Panel Blank Top	82 - 83
	DRG41	6'8"	2'8", 2'10", 3'0", 3'6"	True Four Panel	84 - 85
	DRG4170	7'0"	2'8", 2'10", 3'0"	True Four Panel	84 - 85
	DRG4180	8'0"	2'8", 2'10", 3'0"	True Four Panel	84 - 85
	DRG49	6'8"	2'8", 2'10", 3'0"	3/4 Four Panel	86 - 87
	DRG6C	6'8"	3'0"	Six Panel Craftsman	89
	DRG60	6'8"	2'6", 3'0"	Six Panel	90
	DRG6080	8'0"	2'6", 2'8", 3'0", 3'6"	Six Panel	90
	DRG61	6'8"	2'8", 2'10", 3'0"	Six Panel Utility	91 - 92
	DRG6170	7'0"	2'8", 2'10", 3'0"	Six Panel Utility	91 - 92
	DRG6180	8'0"	2'8", 2'10", 3'0"	Six Panel Utility	91 - 92
	DRG6B	6'8"	2'8", 2'10", 3'0"	Six Panel w/ 10" Bottom Rail	91
	DRG63	6'8"	2'8", 2'10", 3'0"	True Six Panel Narrow	94 - 95
	DRG80	6'8"	3'0"	Eight Panel, Center Arch	96
	DRG8080	8'0"	3'0", 3'6"	Eight Panel, Center Arch	96
	DRG90	6'8"	2'8", 3'0"	Nine Panel	97
	DRG9180	8'0"	3'0"	Nine Panel	98
	ACDSGT2704	3"	27"	4 Block Dentil Shelf	99
	ACDSGT2716	3 2/3"	27 1/9"	16 Block Dentil Shelf	99
SMOOTH	DRS00	6'8"	2'0", 2'4" 2'6", 2'8", 2'10", 3'0", 3'6"	Flush	104 - 106
	DRS0070	7'0"	2'0", 2'4" 2'6", 2'8", 2'10", 3'0", 3'6"	Flush	104 - 106
	DRS0080	8'0"	2'0", 2'4" 2'6", 2'8", 2'10", 3'0", 3'6"	Flush	104 - 106
	DRS2B	6'8"	2'8", 2'10", 3'0"	Two Panel	107 - 108
	DRS2B80	8'0"	2'8", 2'10", 3'0"	Two Panel	107 - 108
	DRS2D	6'8"	2'8", 2'10", 3'0"	Two Panel, Arch Panel	109 - 110
	DRS2D80	8'0"	2'8", 2'10", 3'0"	Two Panel, Arch Panel	109 - 110
	DRS2G	6'8"	2'8", 2'10", 3'0"	Cottage Two Panel	112 - 113
	DRS2G80	8'0"	2'8", 2'10", 3'0"	Cottage Two Panel	112 - 113
	DRS20	6'8"	3'0"	3/4 Heritage	114
	DRS29	6'8"	2'8", 2'10", 3'0"	3/4 Two Panel	115 - 116
	DRS2980	8'0"	2'8", 2'10", 3'0"	3/4 Two Panel	115 - 116
	DRS3C	6'8"	3'0"	Direct Glazed Craftsman	118
	DRS3C80	8'0"	3'0"	Direct Glazed Craftsman	118

SERIES	CODE	HEIGHT	WIDTH	DESCRIPTION	PAGE	
SMOOTH	DRS3E	6'8"	3'0"	3/4 Elite	119	
	DRS3P	6'8"	3'0"	3/4 Premium	120	
	DRS3080	8'0"	2'8", 3'0", 3'6"	3/4 Three Panel	121 - 122	
	DRS31	6'8"	3'0"	Three Panel	122	
	DRS3170	7'0"	3'0"	Three Panel	122	
	DRS40	6'8"	2'6", 2'8", 2'10", 3'0"	Four Panel Blank Top	124 - 125	
	DRS41	6'8"	2'8", 2'10", 3'0"	True Four Panel	126 - 127	
	DRS4170	7'0"	2'8", 2'10", 3'0"	True Four Panel	126 - 127	
	DRS4180	8'0"	2'8", 2'10", 3'0"	True Four Panel	126 - 127	
	DRS42	6'8"	2'6"	Four Panel Blank Top	124	
	DRS49	6'8"	2'8", 2'10", 3'0"	3/4 Four Panel	128 - 129	
	DRS6C	6'8"	3'0"	Six Panel Craftsman	130	
	DRS60	6'8"	2'6", 3'0"	Six Panel	131	
	DRS6080	8'0"	2'6", 2'8", 3'0"	Six Panel	131	
	DRS6B	6'8"	2'8", 2'10", 3'0"	Six Panel w/ 10" Bottom Rail	132	
	DRS61	6'8"	2'8", 2'10", 3'0"	Six Panel Utility	132 - 133	
	DRS6170	7'0"	2'8", 2'10", 3'0"	Six Panel Utility	132 - 133	
	DRS6180	8'0"	2'8", 2'10", 3'0"	Six Panel Utility	132 - 133	
	DRS63	6'8"	2'8", 2'10", 3'0"	True Six Panel Narrow	134 - 135	
	DRS80	6'8"	3'0"	Eight Panel, Center Arch	136	
	DRS8080	8'0"	3'0", 3'6"	Eight Panel, Center Arch	136	
	DRS90	6'8"	2'8", 3'0"	Nine Panel	137	
	DRS1K	6'8"	2'8", 2'10", 3'0"	One Panel Square Top Shaker	138	
	DRS2K	6'8"	2'8", 2'10", 3'0"	Two Panel Square Top Shaker	138	
	DRS3F	6'8"	2'8", 2'10", 3'0"	Three Panel Shaker Craftsman	139	
	DRS3F80	8'0"	3'0"	Three Panel Shaker Craftsman	139	
	DRS50	6'8"	2'8", 2'10", 3'0"	Five Panel Shaker Craftsman	140	
	ACSDW23005			17 1/8" (4 pcs)	3-Lite SDL Bars for 6'8" Door	142
	ACSDW23001			23" (4 pcs)	3-Lite SDL Bars for 8'0" Door	142
	ACSDW23006			25 3/4" (2 pcs), 8 21/32" (8 pcs)	6-Lite SDL Bars for 6'8" Door	142
	ACSDW23002			26" (2 pcs), 11 3/16" (8 pcs)	6-Lite SDL Bars for 8'0" Door	142
	ACSDW23004			8 3/4" (2 pcs)	2-Lite SDL Bars for 6'8" and 8'0" Sidelite	142
	ACDSSW2404			24"	4 Block Dentil Shelf	143
	ACDSSW2704			27"	4 Block Dentil Shelf	143
	ACDSSW2716			27 1/9"	16 Block Dentil Shelf	143
TRUE WHITE OAK	DRW00	6'8"	2'0", 2'4" 2'6", 2'8", 2'10", 3'0"	Flush	146 - 147	
	DRW0070	7'0"	2'0", 2'4" 2'6", 2'8", 2'10", 3'0"	Flush	146 - 147	
	DRW0080	8'0"	2'0", 2'4" 2'6", 2'8", 2'10", 3'0"	Flush	146 - 147	
	DRW40	6'8"	2'6", 2'8", 2'10", 3'0"	Four Panel Blank Top	148 - 149	
	DRW41	6'8"	2'8", 2'10", 3'0"	True Four Panel	150 - 151	
	DRW60	6'8"	2'6", 3'0"	Six Panel	152	
	DRW6080	8'0"	2'6", 3'0"	Six Panel	152	
	DRW61	6'8"	2'6", 2'8", 2'10", 3'0"	Six Panel Utility	153 - 154	
	DRW6170	7'0"	2'8", 2'10", 3'0"	Six Panel Utility	153 - 154	
	DRW63	6'8"	2'8", 2'10", 3'0"	True Six Panel Narrow	156 - 157	

SERIES	CODE	HEIGHT	WIDTH	DESCRIPTION	PAGE
ONELITE SERIES	DRS11	6'8"	3'0"	Full Lite - Commercial ADA	160
	DRS1170	7'0"	3'0"	Full Lite	160
	DRS1180	8'0"	3'0"	Full Lite	160
	DRG12	6'8"	2'8", 3'0"	Flush Glazed Half Lite	161
	DRG12 G09	6'8"	2'8", 3'0"	9 Lite GBG	161
	DRG12B	6'8"	2'8", 3'0"	Half Lite with Miniblinds	161
	DRS12	6'8"	2'8", 3'0"	Flush Glazed Half Lite	162
	DRS12 G09	6'8"	2'8", 3'0"	9 Lite GBG	162
	DRS12B	6'8"	2'8", 3'0"	Half Lite with Miniblinds	162
	DRS13	6'8"	2'6", 2'8", 3'0"	Flush Glazed 3/4 Lite	163
	DRS1380	8'0"	2'6", 2'8", 3'0"	Flush Glazed 3/4 Lite	163
	DRM13	6'8"	2'6", 2'8", 3'0"	Flush Glazed 3/4 Lite	164
	DRM1380	8'0"	2'6", 2'8", 3'0"	Flush Glazed 3/4 Lite	164
	ACSDM/S1368L08C	1 1/4"	48 5/32" (2 pcs), 12 59/64" (12 pcs)	8-Lite SDL Bars for 6'8" Door	165
	ACSDM/S1380L10C	1 1/4"	64 5/32" (2 pcs), 12 59/64" (16 pcs)	10-Lite SDL Bars for 8'0" Door	165
NOVA SERIES	DRS1DL	6'8"	2'0", 2'6", 2'8", 3'0"	Smooth Direct Glazed Full Lite w/ LowE	168 - 169
	DRS1D80L	8'0"	2'0", 2'6", 2'8", 3'0"	Smooth Direct Glazed Full Lite w/ LowE	168 - 169
	DRF1DL	6'8"	2'0", 2'6", 2'8", 3'0"	Fir Direct Glazed Full Lite w/ LowE	168 - 169
	DRF1D80L	8'0"	2'0", 2'6", 2'8", 3'0"	Fir Direct Glazed Full Lite w/ LowE	168 - 169
	DRS1SL	6'8"	2'0", 2'6", 2'8", 2'10", 3'0"	Brushed Direct Glazed Full Lite w/LowE	170 - 171
	DRS1S80L	8'0"	2'0", 2'6", 2'8", 2'10", 3'0"	Brushed Direct Glazed Full Lite w/LowE	170 - 171
	DRS1STSL	6'8"	2'0", 2'6", 2'8", 2'10", 3'0"	Brushed Direct Glazed Full Lite w/Translucent	170 - 171
	DRS1STSL80	8'0"	2'0", 2'6", 2'8", 2'10", 3'0"	Brushed Direct Glazed Full Lite w/Translucent	170 - 171
	DRS1SBL	6'8"	2'0", 2'6", 2'8", 2'10", 3'0"	Brushed Direct Glazed Full Lite w/Miniblind	170 - 171
	DRS1S80BL	8'0"	2'0", 2'6", 2'8", 2'10", 3'0"	Brushed Direct Glazed Full Lite w/Miniblind	170 - 171

THE DOOR OF BEAUTY AND INNOVATION





PlastproInc.com

5200 W. Century Blvd, 9th Floor ■ Los Angeles, CA 90045

Phone: (800) 779-0561 ■ Fax: (310) 693-8620



© 2020 Plastpro Inc. All Rights Reserved

Product # MKLFLB2020 Updated Jan 2020