



Neuma
DOORS®

**2020 COLLECTION
DESIGNED FOR IMPACT**



About Neuma Doors

Neuma Doors stands apart as the industry leader in quality and design innovation. Backed by the strength of Nan Ya Plastics Corp. USA, our vertical integration incorporates comprehensive quality control measures through each step of the production cycle, from the manufacture of raw materials to the final door assembly. Our dedication to production excellence and environmental preservation has been recognized with ISO 9001 and ISO 14001 certifications.

Whether your patio door is the gateway to backyard recreation and relaxation, or a busy access point to your home, Neuma Doors' blend of function and style will provide years of enjoyment with minimal maintenance.



Table of

Contents

Neuma Benefits

08	Complete Door System
10	Energy Efficiency
12	Impact Options
14	Door Design

Products

16	Hinged Series
22	Vented Sidelight
24	Hinged Units and Dimensions
35	Hinged Test Results
40	Folding Series
43	Folding Units and Dimensions
43	Folding Test Results
44	Gliding Series
50	Gliding Units and Dimensions
55	Gliding Test Results
58	Bypass Gliding Series
62	Bypass Gliding Units and Dimensions
63	Bypass Gliding Test Results

Design Options

64	Transom and Sidelight Options
69	Glazing Options
69	GBG & SDL Options
71	Blinds Between Glass
72	Finish Options
74	Hardware Options
77	Screen Options
77	Brickmold Options

Guides

78	Product Details
79	Door Design Specifications
80	Handing Guide
82	Painting Guide
83	Staining Guide
84	Cleaning and Maintenance
86	Sound Construction Practices
89	Warranty

*** Colors and finishes in this publication are not actual representations.

Designed for Impact

As an entry point to your home, it is essential that your patio door provide safety and security as well as protection against incoming weather. Neuma Doors are designed to withstand the impact of extreme weather conditions. Our precision engineered door units protect your home against water infiltration and stand up against extreme heat and cold.

Neuma Doors offers a variety of impact rated door options for added protection. Designed to safeguard people and property, Neuma Impact Doors are built to stay strong during high wind events that can hurl debris at the door. The high impact fiberglass panels with a dense foam core and laminated impact glass work together to keep the effects of extreme weather from penetrating the door. For safety and security, the laminated glass in an impact door contains a cut resistant vinyl interlayer that remains intact and adheres to glass fragments should the glass ever be broken.



Designed for Visual Impact

Something as simple as a door can have a dramatic Visual Impact on your home. The right door brings out the best qualities in your home and can be the focal point of your indoor-outdoor patio space. Clean lines, rich textures, and tall glass panes provide your home with a strong atmosphere of elegance. Low maintenance fiberglass is easy to clean should you chose to let the standard finish shine and easy to paint or stain, allowing you to add a personal flair.

Extend your living area with a Neuma Patio Door and create a flexible space that accommodates the way you live. Open or closed, you can appreciate expansive, unobstructed views and create a space that is open to the outdoor views and infused with natural light with all Nemua Door systems. Our patio doors are designed with visual impact in mind, offering flush glazed windows, realistic woodgrain patterns, and a wide range of transoms and sidelights. With customization options such as color, lite pattern, and configuration, your door will be a true reflection of your style and leave a lasting impact on all of your guests.



Designed as a Complete Door System

Neuma Doors, designed as a complete door system, are a smart investment in your home due to their outstanding durability and energy efficiency.

Hydroshield Protection

Crafted with Hydroshield Technology, every Neuma Door contains the best combination of performance, durability, security and appearance.

Neuma Door systems are precision engineered to provide protection against water infiltration. The specially engineered composite material will never absorb water, eliminating the problems commonly associated with wood and metal doors.



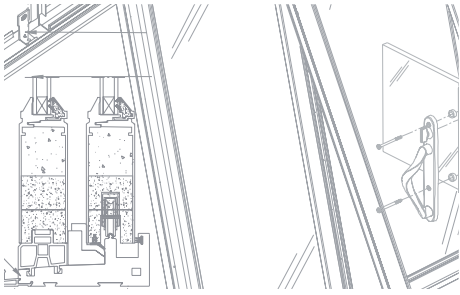

Precision Engineered

Neuma Doors are complete door systems with components purposely designed to work together for optimal performance with lasting durability. The door panel, frame, hardware and weather-stripping all function cohesively to provide superior protection.



Factory Assembled

Neuma Doors are meticulously assembled in our state of the art factory by craftsmen with an eye for detail. A factory assembled pre-hung Neuma Door reduces the chance of possible errors in assembly that sometimes occur with a field-assembled door.



Tested as a Complete Unit

Neuma Doors undergo extensive testing. We test the integrity of our entire door system, not only the individual components. This comprehensive testing provides assurance that the entire door system performs to expectations.



Composite Frame

The composite frame is made of non-porous material that is impervious to penetration by water. The frame will never absorb water, swell, split or rot, minimizing the need for maintenance and extending the life of the door.



Sturdy Hardware

As a complete system, Neuma Doors include hardware components. From the stainless steel rollers and hinges, integrated flush bolts, to the included handle set in your choice of style and color, each component is built to last.



High Quality Fiberglass Door Panels

Thanks to advancements in manufacturing, Neuma fiberglass panels are available in highly realistic wood-grain or smooth texture options that are easy to stain or paint and even easier to maintain.

Constructed from high compression molded fiberglass with full composite stiles and rails, Neuma Door panels are not susceptible to weather conditions or pest infestations. Unlike doors made from other materials, Neuma Doors will not absorb water, dent or rot; resulting in a reliable option that will look beautiful for years to come.



Energy Efficient

An ENERGY STAR certified Neuma Door is not only a beautiful addition to your home, but helps save money on heating and cooling costs year-round. Standard LoE366 insulated glass with Argon and an insulating CFC-free foam core provides superior energy performance.



Flush Glazed Door Panels

The flush glazed system of a Neuma Door offers a clean finished appearance and additional protection against weather intrusion. The integrated glazing bead allows the glass to sit flush within the door without an unsightly screwed on glazing frame. The easily removed glazing bead allows replacement of the door glass if needed.

Designed for Energy Efficiency

Environmental Responsibility

As part of our ongoing commitment to environmental conservation, Neuma Doors, backed by Nan Ya Plastics Corp. USA, has developed comprehensive programs focused on recycling, reducing carbon emissions and water and energy conservation.

Neuma Doors are manufactured with recycled materials and do not contain any harmful CFC's that damage the Earth's ozone layer.

As the leading manufacturer of energy efficient patio doors, we help reduce home energy use across the country and are a proud partner with the Environmental Protection Agency's ENERGY STAR Program.

ENERGY STAR is an EPA voluntary program that helps businesses and individuals save money and protect our climate through superior energy efficiency. ENERGY STAR certified doors lower energy bills, reduce greenhouse gas emissions from power plants and help keep the indoor environment consistently comfortable.

Reduce Your Energy Use

Home energy use accounts for about one-quarter of your carbon footprint. As part of an energy efficient home, ENERGY STAR certified doors help reduce your energy use.

Stay Warm in the Winter

With ENERGY STAR certified Neuma Doors, the interior glass stays warmer, so you can stay warm even when the outside temperature is below freezing.

Stay Cool in the Summer

ENERGY STAR certified doors help you stay cool on hot summer days. By reducing the "heat gain" into your home without reducing the visible light, you get a bright space without the extra heat.

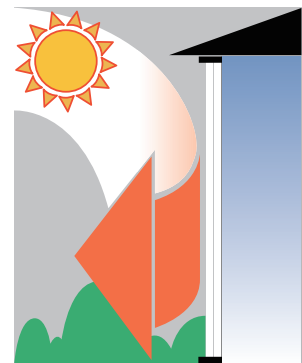

Rejects the sun heat & damaging UV rays in **summer**

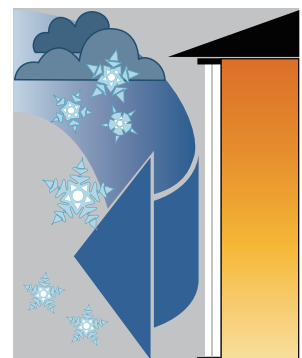

Keeps the cold weather out and the warm air in during the **winter**

What makes a Neuma Door Energy Efficient?

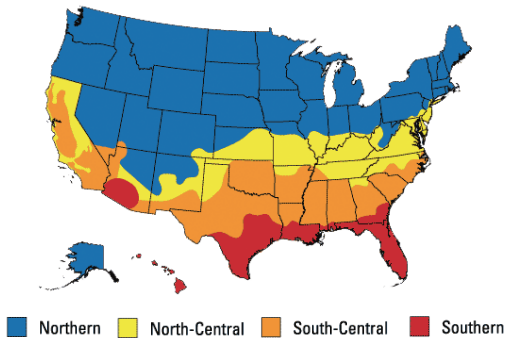

Neuma Doors meet or exceed the rigorous testing in EPA-recognized laboratories and meet the U-Factor and SHGC (Solar Heat Gain Coefficient) qualifications for Energy Star Certification **EVERYWHERE** in the United States.



Door		
Glazing Level	U-Factor ¹	SHGC ²
Opaque	≤ 0.17	No Rating
≤1/2-Lite	≤ 0.25	≤ 0.25
>1/2- Lite	≤ 0.30	Northern North-Central ≤ 0.40
		Southern South-Central ≤ 0.25

U-Factor measures how well the door prevents heat from escaping the home. The lower the U-Factor, the better the door performs at keeping heat inside.

SHGC measures how much heat from the sun is blocked by the door. The lower the SHGC, the better the protection against solar heat.



- 1 Insulated energy efficient glass reduces heat flow.
- 2 Improved CFC-free polyurethane foam core for energy efficient insulation.
- 3 Precision engineered door system with weather stripping for reduced air leakage.



We believe that doors should be beautiful and durable, protecting your family while maintaining exceptional style. Neuma Doors undergo rigorous testing to help ensure that each door meets our highest standards, meets building code requirements and withstands the test of time without compromising beauty.

Designed to perform well for years to come, Neuma Doors are tested in accordance with the following test standards:

- | | | |
|--------------------|--|---------------------------------|
| ASTM E 283 | NFRC 100 / 200 / 500 | Forced entry resistance test |
| ASTM E 331 / E 547 | ASTEM E90 / STC / OITC | Impact test |
| ASTM E 330 | AAMA 920 | Air / water / structural test |
| ASTM E1886 / E1996 | AAMA / WDMA / CSA 101 / I.S./A440 (NAFS) | Wind pressure cycle test |
| AAMA 1304 | Air infiltration | Energy efficiency |
| TAS 201 | Water resistant | Sound transmission |
| TAS 202 | Uniform structural load | Operating cycle test |
| TAS 203 | Impact / cycle test | North America fenestration test |

DESIGNED TO LAST

Impact Options

Designed to protect people and property during violent storms, Neuma's Impact Rated Doors provide the ultimate storm protection for your home and include the following standard features:

- High impact fiberglass panels for strength and durability
- 1" insulated laminated impact glass for extra security and protection against broken glass
- Multi-point lock for added security
- HPVD (High Physical Vapor Deposition) for additional protection in harsh environments

Storm damage can be caused by debris that is picked up and hurled towards your home in high winds. These objects, set on a collision course with your home, can penetrate doors and provide an entry point for water, high winds and additional debris. Our Impact Doors stand up to the harshest conditions and are more resistant to denting than traditional metal doors.

If the glass on a Neuma Impact Door is broken, our standard 1" insulated laminated impact glass maintains its integrity thanks to the vinyl interlayer which remains in the door frame. This vinyl interlayer stays intact and prevents broken glass fragments and additional debris from entering the home. Unlike most other doors on the market, Neuma Doors' unique removable glazing bead allows for glass replacement without the added expense of purchasing an entirely new unit.

Neuma's Impact Rated Doors are certified by the Texas Department of Insurance and Florida Building Code, with HVHZ options available for use in High Velocity Hurricane Zones. Neuma Doors Impact Hinged Inswing and Gliding Doors can withstand windstorm of over 145 mph and our Hinged Outswing can withstand windstorm as high as 170 mph. (AAMA / NWWDA / CAS101 / I.S. 2 / A440-8)

With a variety of door styles, design options and configurations, Neuma Doors are an affordable option to expensive and unsightly roll-down or accordion style shutters



Our Impact Series helps preserve the house's envelope to minimize the damage from the storm's elements.

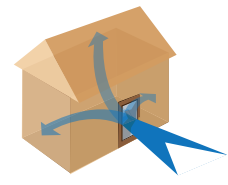

If a home has been breached through a broken door or window, wind can then enter. This causes an increase in pressure that can lift the roof and push the walls outward.

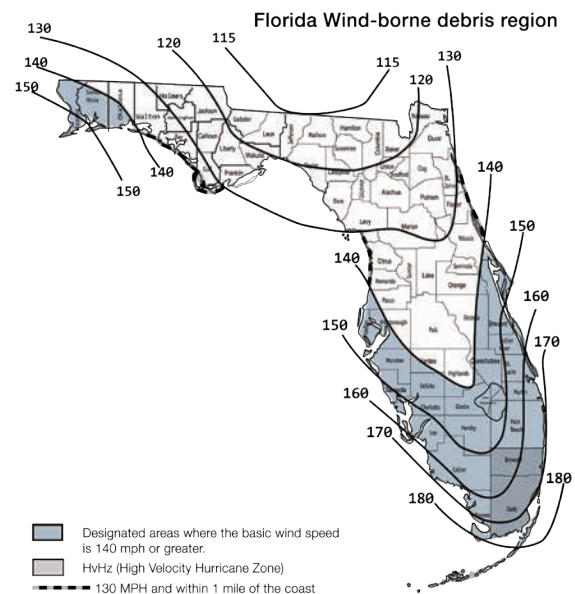

Note : The wind zones are approximate. Please refer to the International Building Code for precise locations.

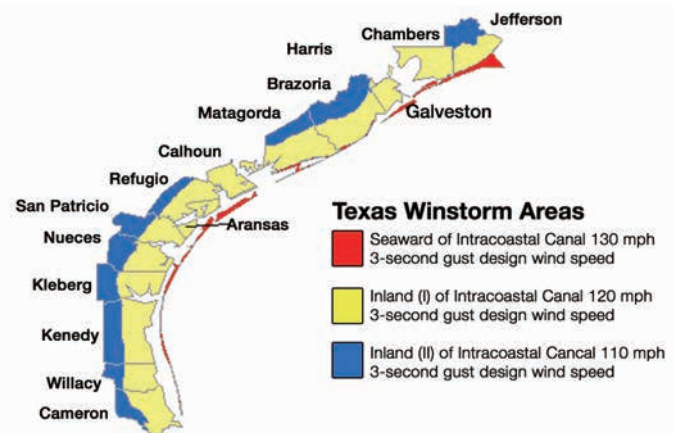

Design The Perfect Door

for your space



Let your home's personality shine through with customizable door options. Neuma Doors provides an array of design options to fit seamlessly with your home's style. Sidelights next to the door or transom windows above the door expand the visual impact, letting in light and creating a larger viewing area. Create a classic look with a traditional SDL (simulated divided lite) pattern. Craft a contemporary look with a bypass or folding door that allows unobstructed views and the flexibility to open your space and blur the lines between indoor and outdoor living. A variety of stain, paint, and hardware finish options allow you to accent your décor and create the perfect door for you.



1 Select Your Door Type

Choose from Hinged, Folding, Gliding or Bypass Gliding Doors.

Select our Full Lite door style for maximum views or choose the ¾ Lite door style for added architectural detail.



2 Select Your Configuration

Select the number of panels. With options from a single door to 4 panel configurations, Neuma offers the best design to fit your space. Our wide range of configurations allows you the flexibility to design your perfect door.

Enhance your door and increase your viewing area with sidelights and transoms.



3 Select Your Glass

Add a touch of style to your door with our divided lite options, available as simulated divided lites (SDL) or as grilles between the glass (GBG).

When privacy is a concern, select blinds between the glass, now available in an energy efficient LoE option.

*** Colors and finishes in this publication are not actual representations.



4 Select Your Finishes And Hardware

Choose from our smooth white paintable finish or one of our woodgrain options to best suit your space.



Handlesets and hardware are included with your Neuma Door system. Select the hardware style and color to compliment your home.

HINGED SERIES

- Panels and frames made of fiberglass and composite material with Hydroshield Technology for advanced moisture protection and maximum durability
- Durable fiberglass skins will not rust, dent, split or rot
- Energy Star certified in all 50 States
- Durable CFC-free polyurethane foam panel core
- Stainless steel hinges
- Removable glazing bead for easy glass replacement
- Door heights available in 6'-8", 6'-11", 7'-6" and 8'-0" sizes
- Frames available in 4-9/16" or 6-9/16" sizes
- Thresholds include drainage systems to channel water away from doors
- Paintable smooth surface or unstained woodgrain are standard with pre-finished options available.
- Doors tested for structural stability, water infiltration, air infiltration, forced entry, sound transmission, and energy efficiency





FEATURES

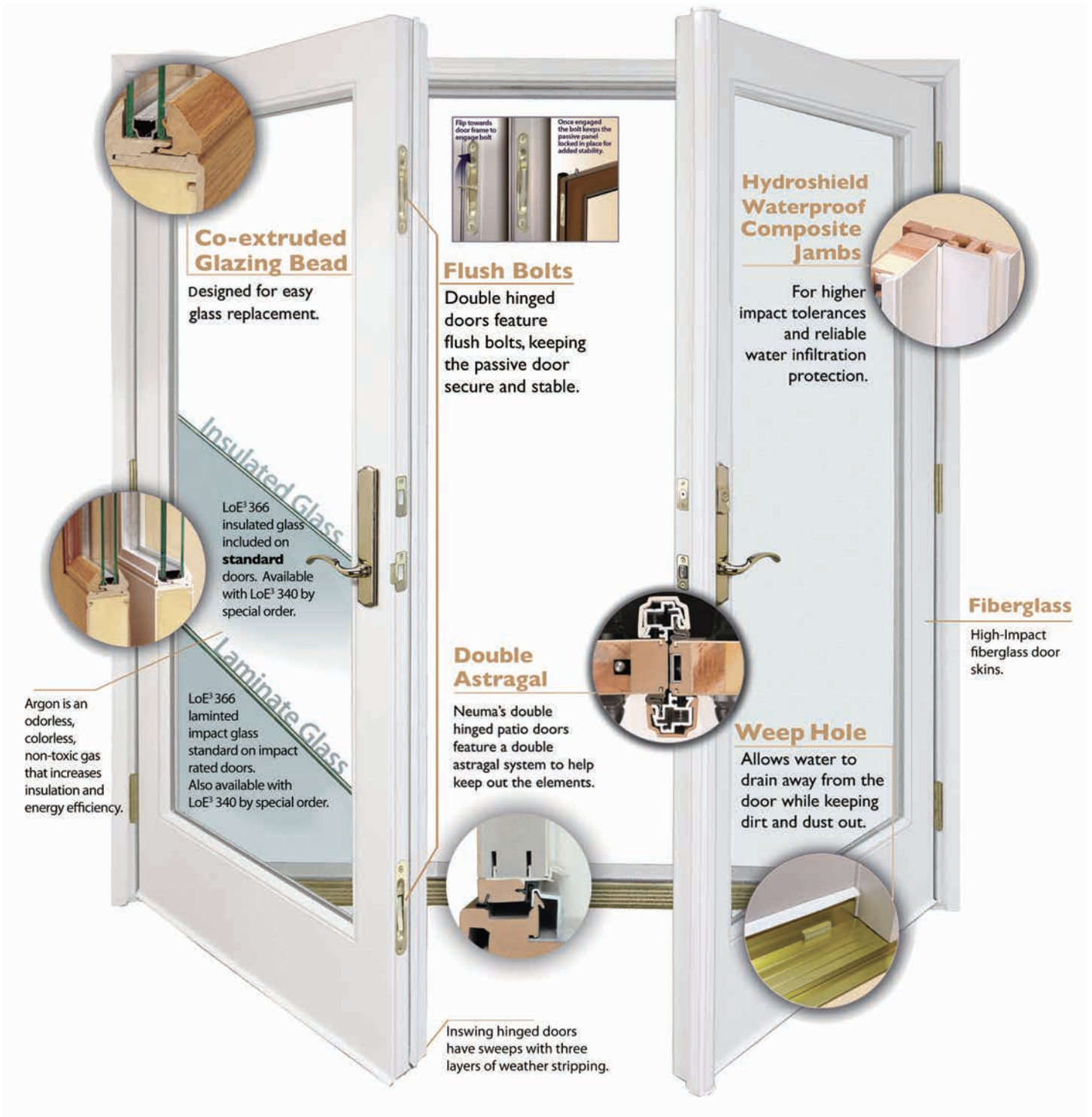

Co-extruded Glazing Bead

Designed for easy glass replacement.

Flush Bolts

Double hinged doors feature flush bolts, keeping the passive door secure and stable.

Hydroshield Waterproof Composite Jamb

For higher impact tolerances and reliable water infiltration protection.

Fiberglass

High-impact fiberglass door skins.

Double Astragal

Neuma's double hinged patio doors feature a double astragal system to help keep out the elements.

Weep Hole

Allows water to drain away from the door while keeping dirt and dust out.

Insulated Glass

LoE³ 366 insulated glass included on **standard** doors. Available with LoE³ 340 by special order.

Laminate Glass

LoE³ 366 laminated impact glass standard on impact rated doors. Also available with LoE³ 340 by special order.

Argon is an odorless, colorless, non-toxic gas that increases insulation and energy efficiency.

Inswing hinged doors have sweeps with three layers of weather stripping.

The Neuma Door system is ready to install and provides complete protection from the elements. Doors and frames are engineered to work together to withstand use in the harshest environments.





SELECT AND BUILD YOUR OWN HINGED UNIT

Single Hinged/ Fixed Units



Double Hinged



Center Hinged



Full Lite Option

Full Lite unit available in smooth white, stainable woodgrain and white woodgrain finishes.

3/4 Lite Option

3/4 Lite design available in a smooth white finish or a mahogany grain that emulates the beauty of natural hard-wood.



Unique to our Center Hinge Design

Neuma's center hinge design has unique features that allow it to withstand the elements and allow for years of reliable use.



1 Our durable aluminum mullion, covered with composite material, can withstand strong winds and heavy rains.



2 Built-in screen channels make retractable screen installation a simple task.

3 Continuous head and sill for increased strength.

Combo Options



Grille Options



Grilles are used to visually divide the glass area of the door for added architectural detail. Grilles Between Glass (GBG) are aluminum grilles sealed between the two layers of glass and offer an attractive low maintenance option. Simulated Divided Lites (SDL) are applied directly to the glass surface and offer a more traditional appearance. Neuma offers standard 10, 12, 15, and 18 grille patterns as well as custom grille patterns available through special order.

Available Grille Patterns

8' Height

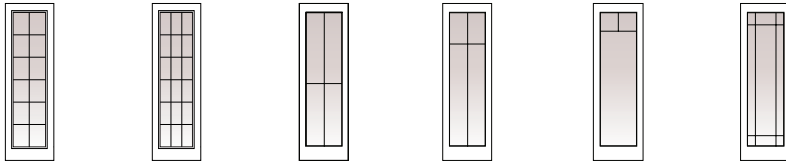

12-Lite 18-Lite 4 Lite 4 Lite Tall 3 Lite Prairie

6'8 & 6'11 Height

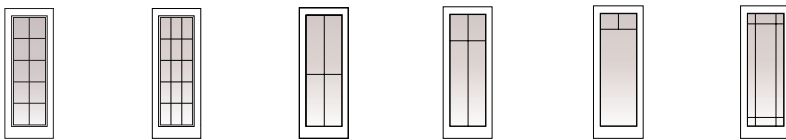

10-Lite 15-Lite 4 Lite 4 Lite Tall 3 Lite Prairie

Mull Kits

Hinged Outswing

Hinged Inswing

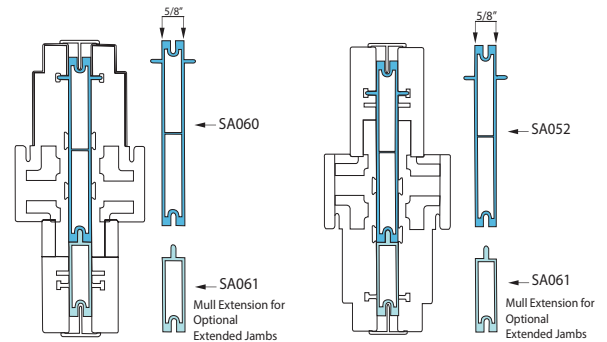

Be creative in building a custom large view hinged door design. Build a three panel hinged door unit with a single opening on a center hinged unit or broaden your double hinged into a 2+1 or 2+2 unit.

Standard Features Chart

Hinged Door - Standard Features	Hinged 6'8" & 6'11"	Hinged Impact 6'8" & 6'11"	Hinged 7'6" & 8'0"	Hinged Impact 7'6" & 8'0"
Smooth White Interior or Unstained Woodgrain	•	•	•	•
Smooth White Exterior or Unstained Woodgrain	•	•	•	•
Tiffany or Royal Handleset in White, Dark Brown, Gold Brass or Satin Nickel	•		•	
HPVD Royal Handleset in Satin Nickel or Gold Brass		•		•
Sill Color Matched with Handleset (white handleset comes with satin nickel sill)	•	•	•	•
Single Point Lock	•			
Multi Point Lock		•	•	•
4 9/16" Jamb Width	•	•	•	•
LoE ³ 366 Glass	•		•	
LoE ³ 366 Laminated Impact Glass		•		•





VENTED SIDELIGHT OPTIONS

Operable Vented Sidelights

- Continuous head and sill, with a mullion system designed to maximize stability and ease of installation.
- Sidelights come standard with multipoint locking system for stability and security.
- Sidelights come standard with stationary screens for maximum comfort. Screens are removable for cleaning.
- No extra assembly required. Vented Sidelight door units are designed and delivered fully assembled.
- Fully operable hinged sidelights
- Available in woodgrain finish
- Optional retractable screens available



Height 6'-8" only
Width 6'-0" and 8'-0"



Shown with golden oak finish, gold brass Royal handle set and craftsman style (GBG).



Fully Operable Hinged Sidelights
Sidelight vents feature a craftsman style thumb-turn.



Shown with medium oak finish and satin nickel Royal handle set.



















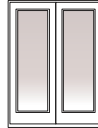
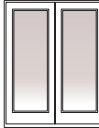
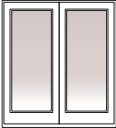



HINGED UNITS AND DIMENSIONS

Full Lite

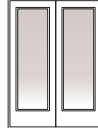
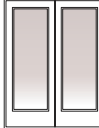
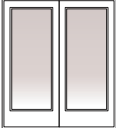
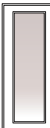
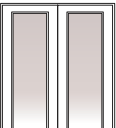
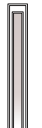
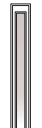
Fixed Sidelight

Single Panel Units

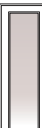
Two Panel Units

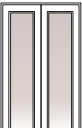
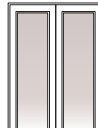
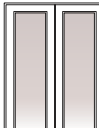
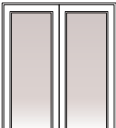
Rough Opening	1'-3/4"	1'-2 3/4"	2'	2'-2 13/16"	2'-7 3/8"	2'-9 3/8"	3'-1 3/8"	4'-2 3/4"	5'	5'-4"	6'		
Unit Dim.	1'	1'-2"	1'-11 1/4"	2'-2 1/16"	2'-6 5/8"	2'-8 5/8"	3'-0 5/8"	4'-2"	4'-11 1/4"	5'-3 1/4"	5'-11 1/4"		
Glass Dim.	7"	7"	13 3/8"	13 3/8"	20"	22"	26"	13 3/8"	20"	22"	26"		
6'-8"	6'-7 1/2"	64"											
			1068	1268	2068	2068	2668	2868	3068	4068	5068	5468	6068
6'-11"	6'-10 1/2"	64"											
			10611	12611	20611	20611	26611	28611	30611	40611	50611	54611	60611
7'-6"	7'-5 1/2"	70"	Glass Dim. 24 1/2"							Glass Dim. 24 1/2"			
													
8'-0"	7'-11 1/2"	80"											
			1080	1280	2080	2080	2680	2880	3080	4080	5080	5480	6080

Full Lite Handing

Inswing

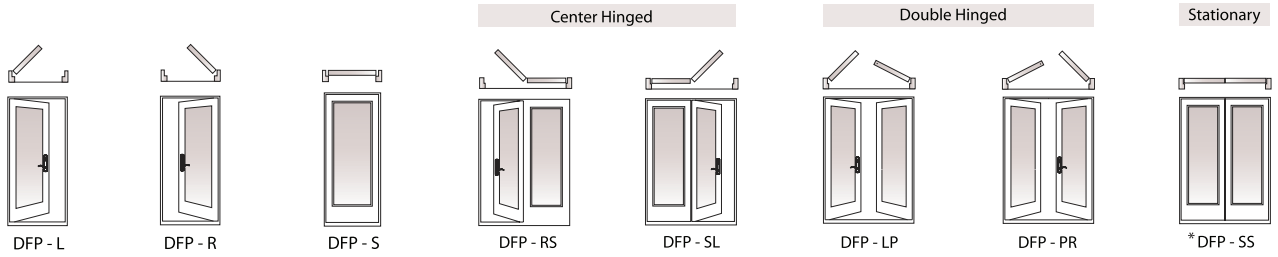

Outswing

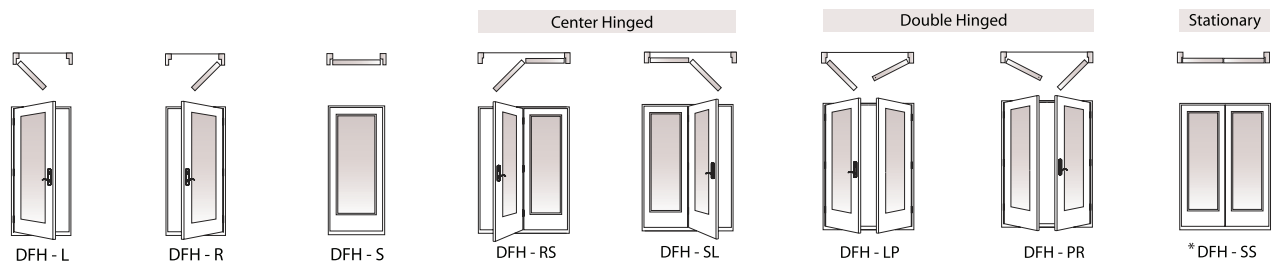

Available Grille Patterns

8' Height

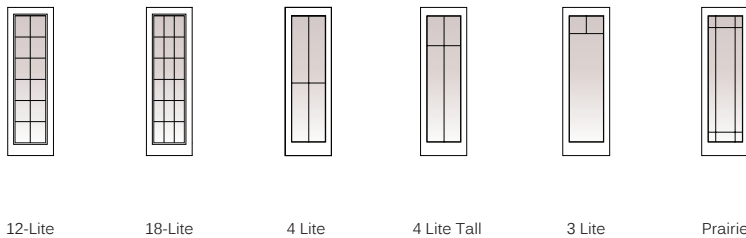

6'8 & 6'11 Height

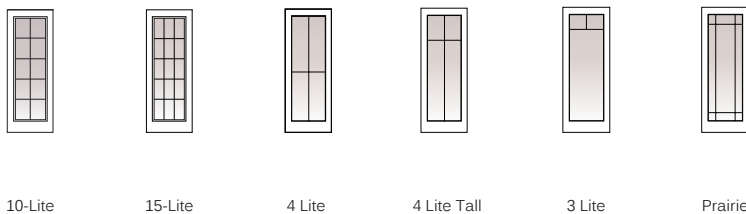

LEGEND

- Handing from exterior view
- Doors are not reversible
- Retractable screen available as an option

P = Passive
 S = Stationary
 R = Hinge at right side exterior view
 L = Hinge at left side exterior view
 DFP = Inswing
 DFH = Outswing

Full Lite

Three Panel Units

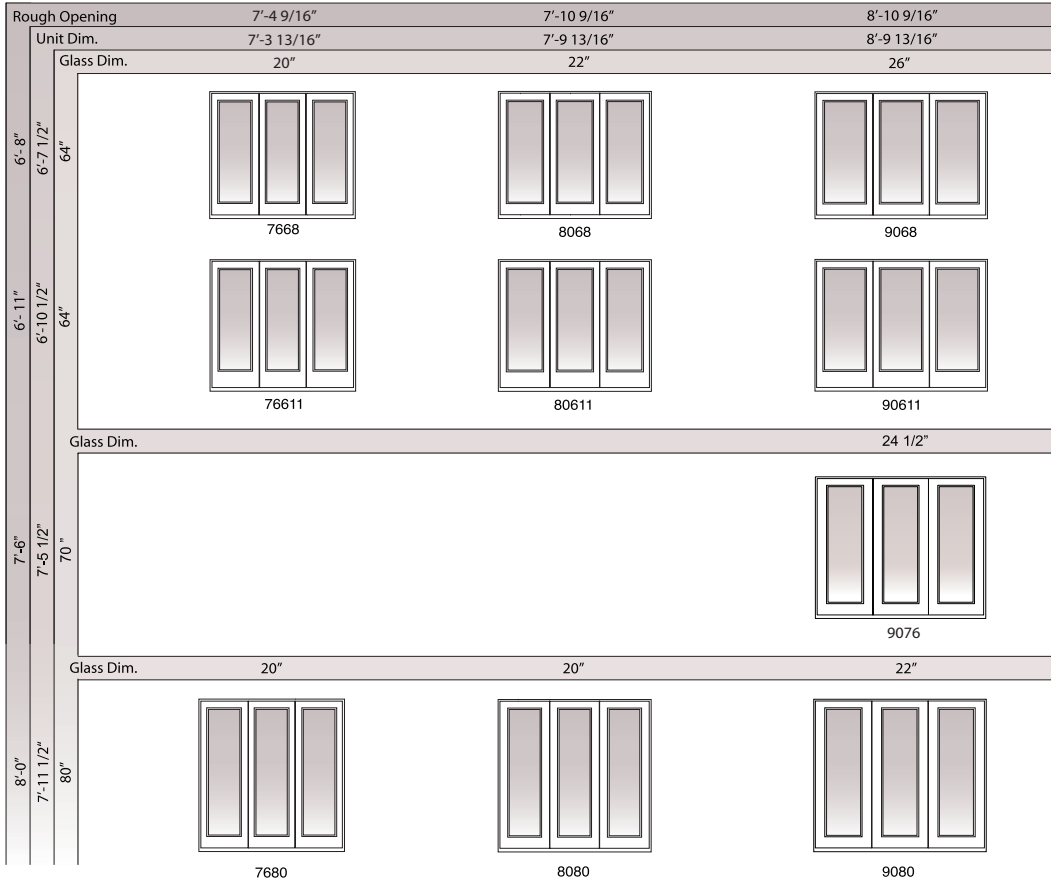

LEGEND

- Handing from exterior view
- Doors are not reversible
- Retractable screen available as an option

S = Stationary
 R = Hinge at right side exterior view
 L = Hinge at left side exterior view
 DFP = Inswing
 DFH = Outswing

Available Grille Patterns

8' Height

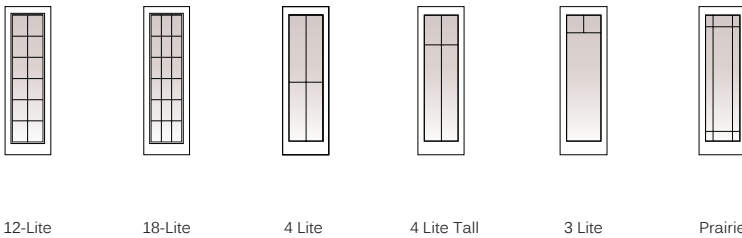

6'8 & 6'11 Height

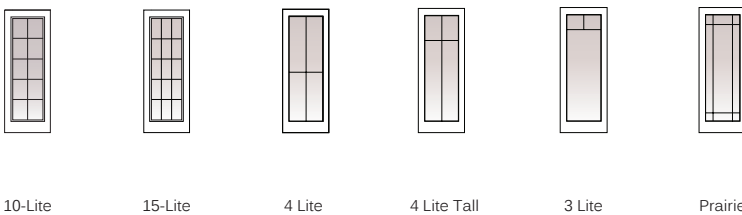

Inswing

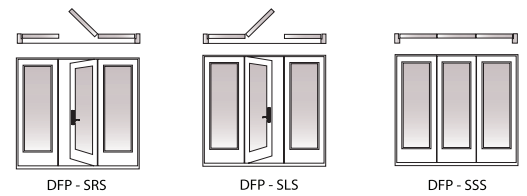

Outswing

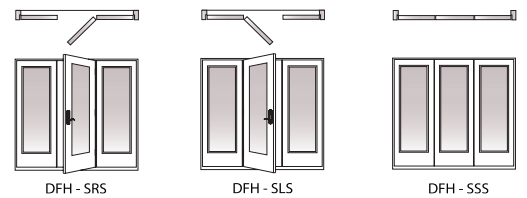

Full Lite Panel Specifications

Fixed Sidelight Panels

Hinged Patio Door - Fixed Sidelights

Inswing

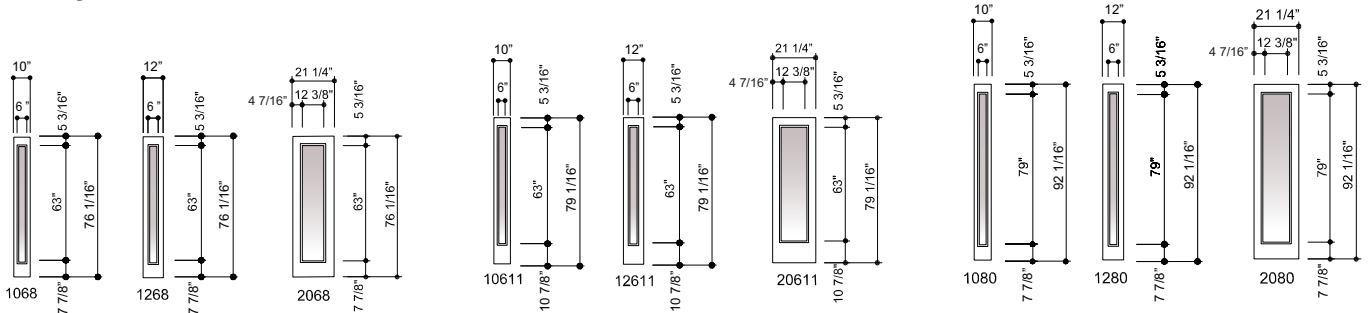

Outswing

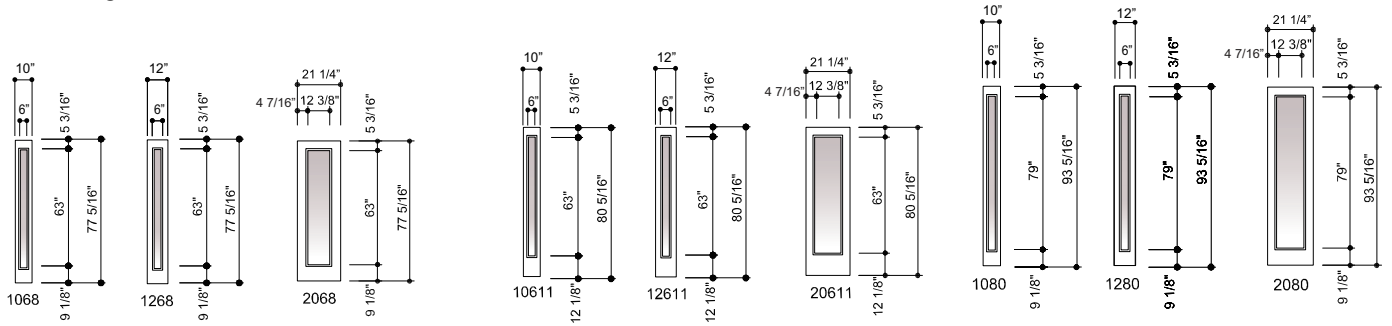

Mull Kits

Hinged Outswing

Hinged Inswing

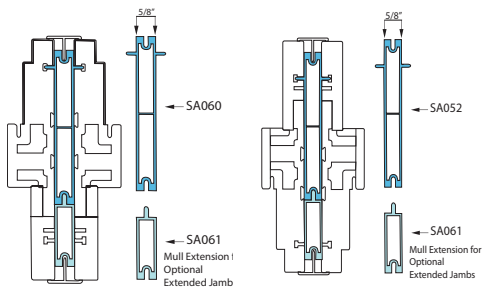

When creating a custom configuration by combining panels and door units, add 5/8" to the unit dimension to allow for the width of the aluminum mull.

ADA Handicap Sill



Full Lite Panel Specifications

Inswing & Outswing Patio Doors

Hinged Patio Door - Inswing

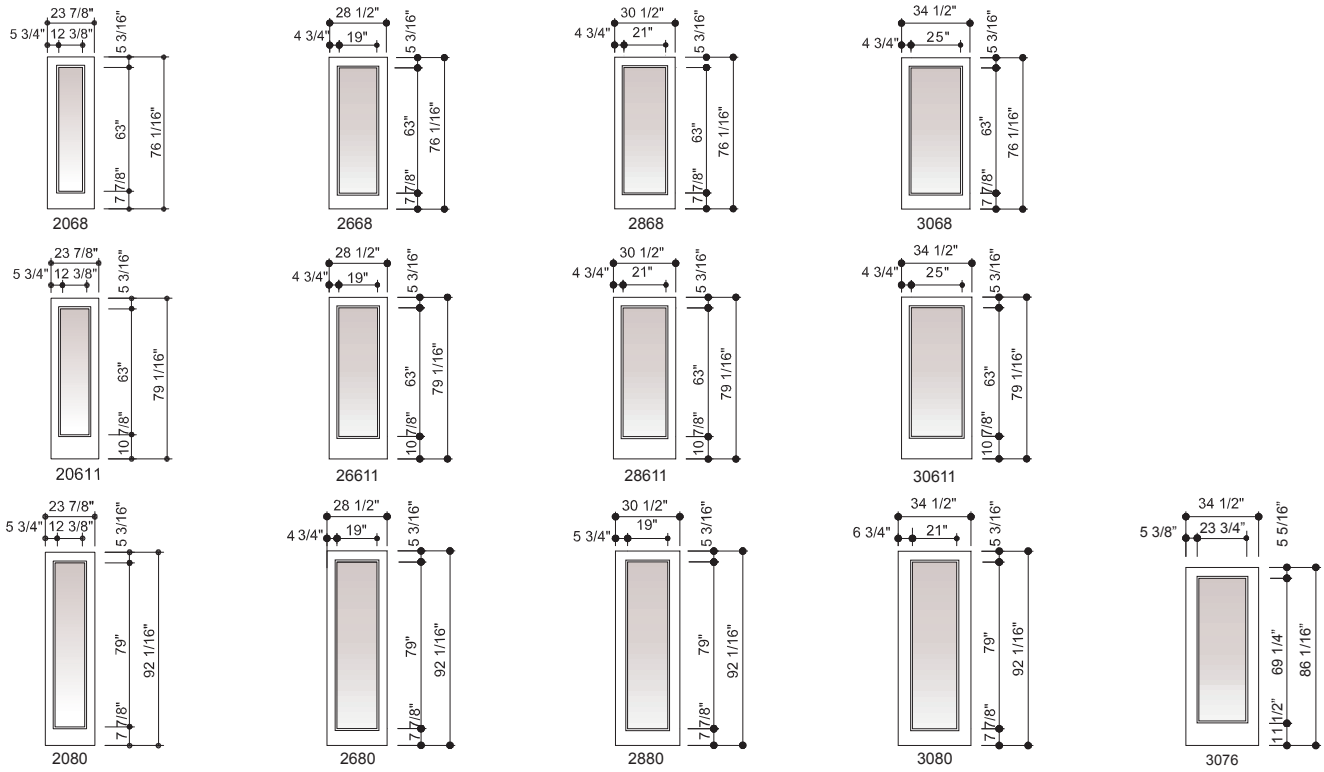

Hinged Patio Door - Outswing

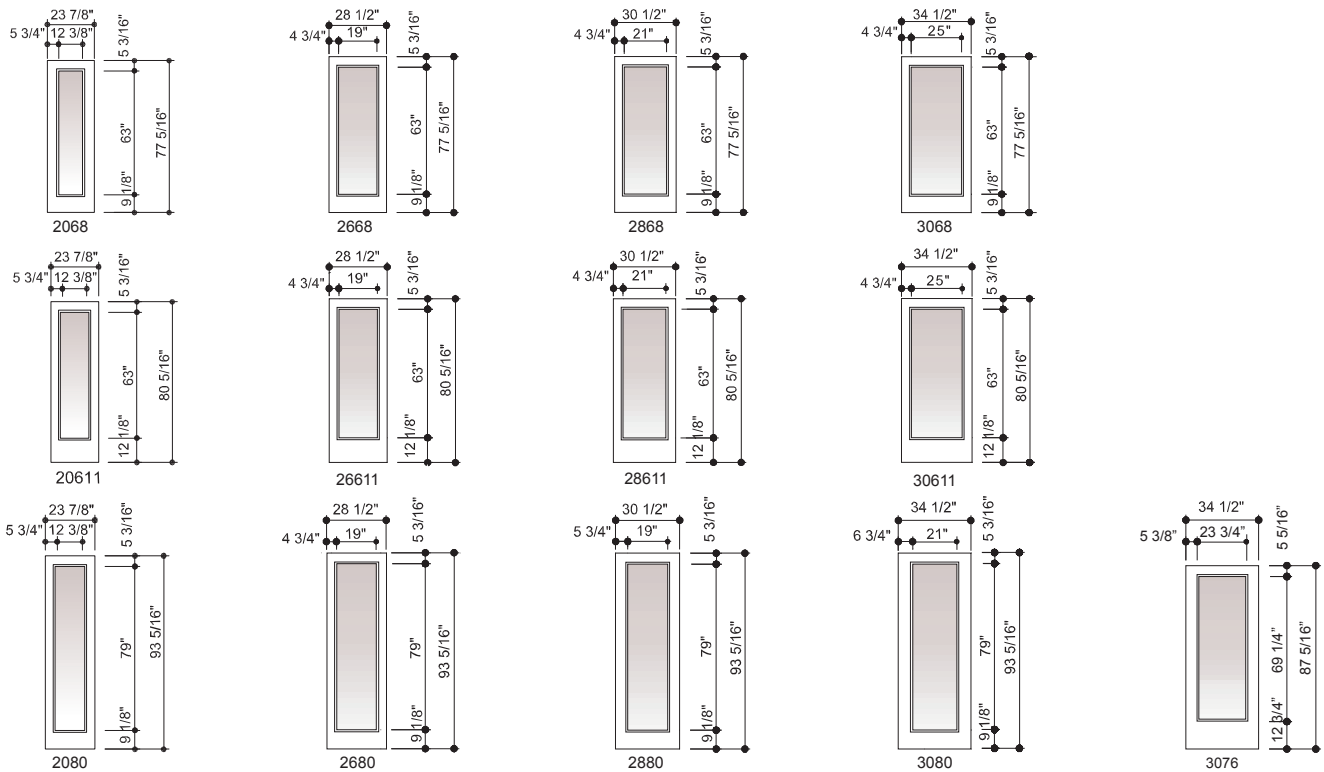









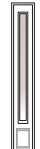
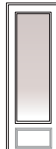

3/4 Lite

Fixed Sidelight

Single Panel Units

Rough Opening		1'-2 3/4"	2'-7 3/8"	2'-9 3/8"	3'-1 3/8"
Unit Dim.		1'-2"	2'-6 5/8"	2'-8 5/8"	3'-0 5/8"
Glass Dim.		7"	20"	22"	26"
6'-8"	6'-7 1/2"	 1268	 2668	 2868	 3068
	48"	 12611	 26611	 28611	 30611
6'-11"	6'-10 1/2" (for Inswing) 6'-9 1/4" (for Outswing)	 1280	 2680	 2880	 3080
	48"	Glass Dim. 8" 20" 22" 26"			
8'-0"	7'-11 1/2"	64"			

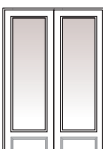
Two Panel Units

Rough Opening		5'	5'-4"	6'
Unit Dim.		4'-11 1/4"	5'-3 1/4"	5'-11 1/4"
Glass Dim.		20"	22"	26"
6'-8"	6'-7 1/2"	 5068	 5468	 6068
	48"	 50611	 54611	 60611
6'-11"	6'-10 1/2" (for Inswing) 6'-9 1/4" (for Outswing)	 5080	 5480	 6080
	48"	Glass Dim. 20" 22" 26"		
8'-0"	7'-11 1/2"	64"		

3/4 Lite Handing

Inswing



DFP - L



DFP - R



DFP - S

LEGEND

- Handing from exterior view
- Doors are not reversible
- Retractable screen available as an option

P = Passive

S = Stationary

R = Hinge at right side exterior view

L = Hinge at left side exterior view

DFP = Inswing

DFH = Outswing

Outswing



DFH - L



DFH - R

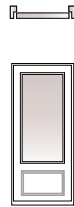

DFH - S

Inswing

Center Hinged

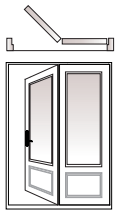

DFP - RS

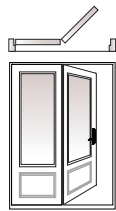

DFP - SL

Double Hinged

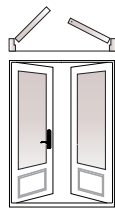

DFP - LP

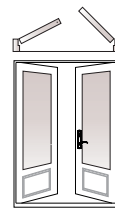

DFP - PR

Stationary



DFP - SS

Outswing

Center Hinged



DFH - RS

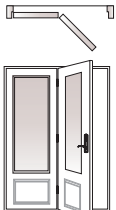

DFH - SL

Double Hinged



DFH - LP

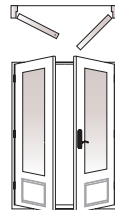

DFH - PR

Stationary

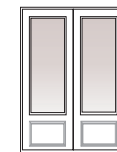

DFH - SS

3/4 Lite

Three Panel Units

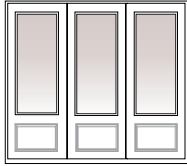
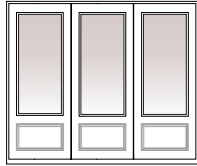
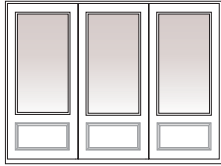
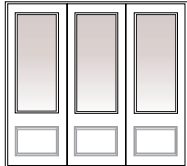
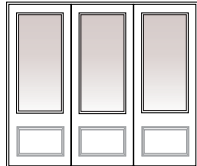
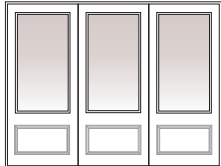
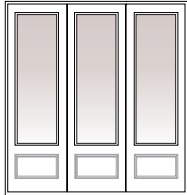
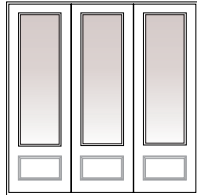
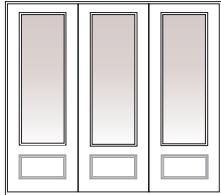
Rough Opening		7'-4 9/16"	7'-10 9/16"	8'-10 9/16"
Unit Dim.		7'-3 13/16"	7'-9 13/16"	8'-9 13/16"
Glass Dim.		20"	22"	26"
6'-8"	6'-7 1/2"			
	48"	7668	8068	9068
6'-11"	6'-10 1/2" (for Inswing)			
	6'-9 1/4" (for Outswing)	76611	80611	90611
Glass Dim.		20"	22"	26"
8'-0"	7'-11 1/2"			
	64"	7680	8080	9080

Inswing

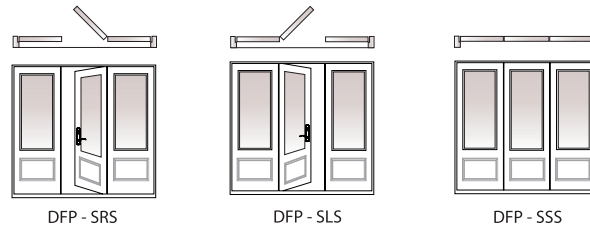

Outswing

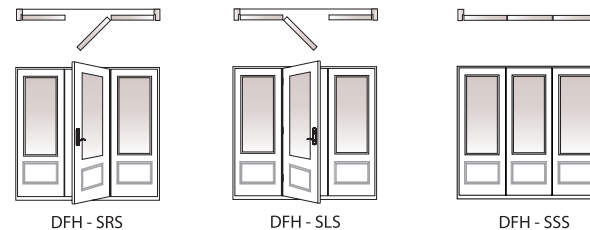

3/4 Lite

Inswing & Outswing Patio Doors

Hinged Patio Door - Inswing

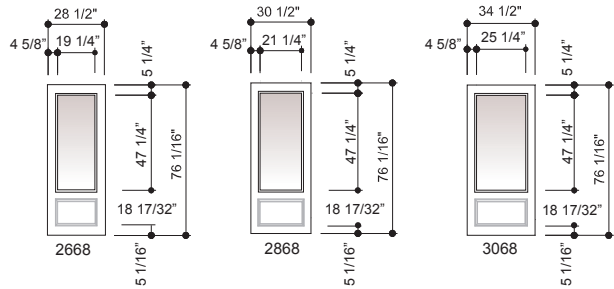

Hinged Patio Door - Outswing

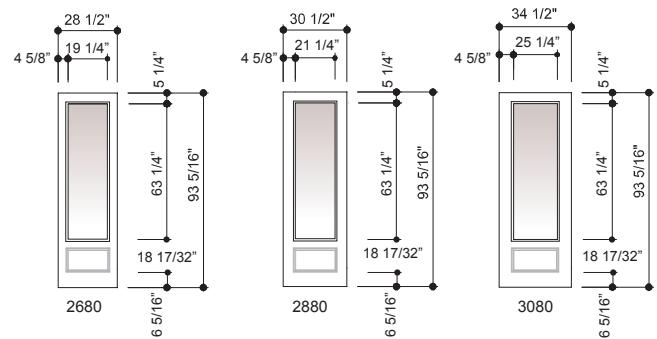
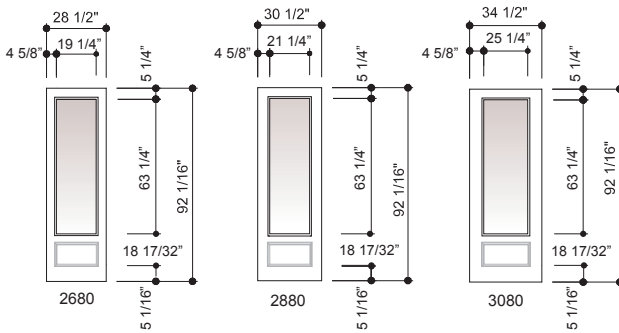
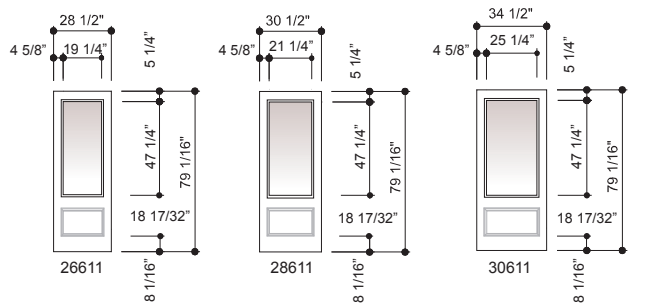
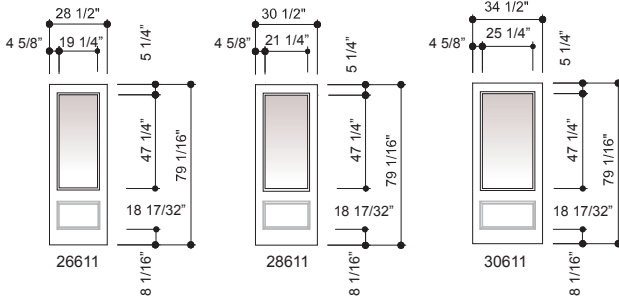
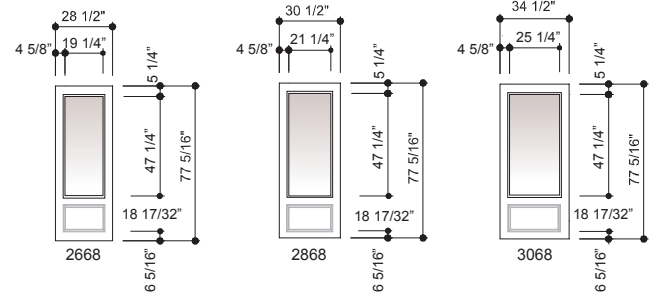

Hinged Patio Door Sidelights - Inswing

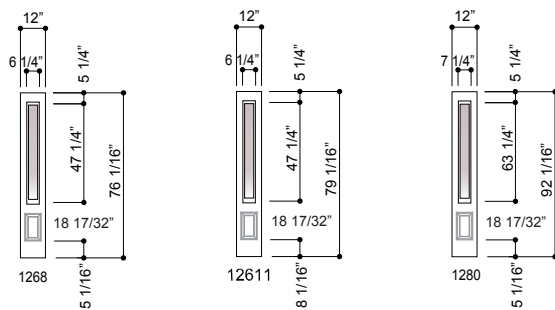

Hinged Patio Door Sidelights - Outswing

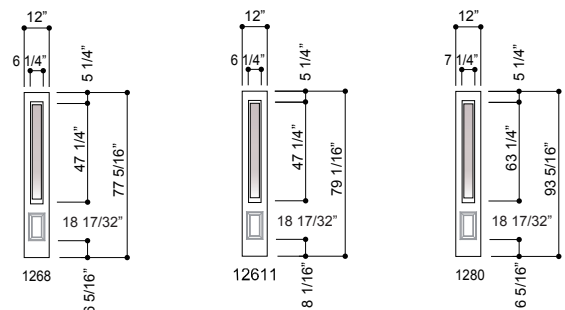

Vented Sidelight

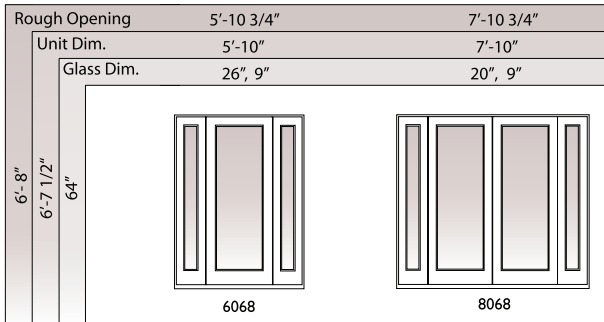

Inswing Vented Sidelight 6'8" Retro Fit

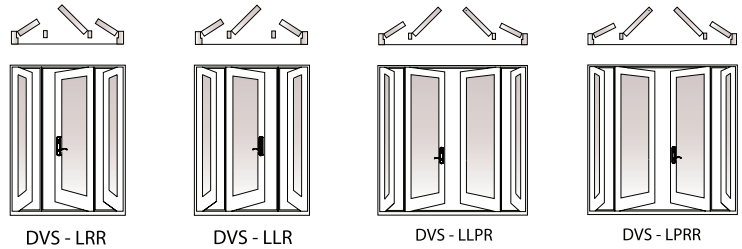

Vented Sidelight Panel Specifications

6068 Vented Sidelight

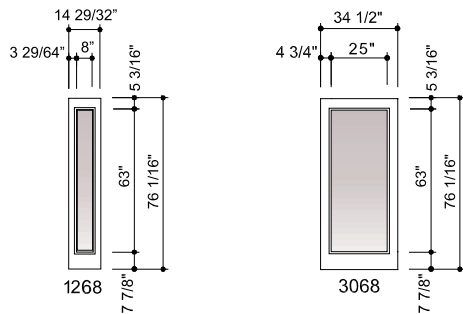

8068 Vented Sidelight

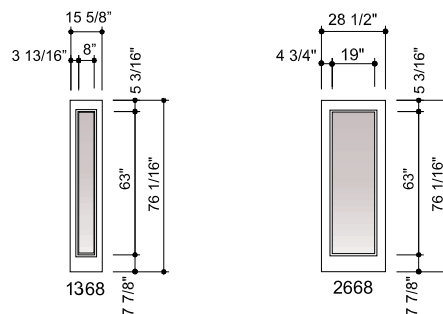

LEGEND

- Handing from exterior view
- Doors are not reversible
- Retractable screen available as an option

P = Passive
 S = Stationary
 R = Hinge at right side exterior view
 L = Hinge at left side exterior view
 DVS = Vented Sidelight

Transoms For Hinged Doors

Single Panel Units

Two Panel Units

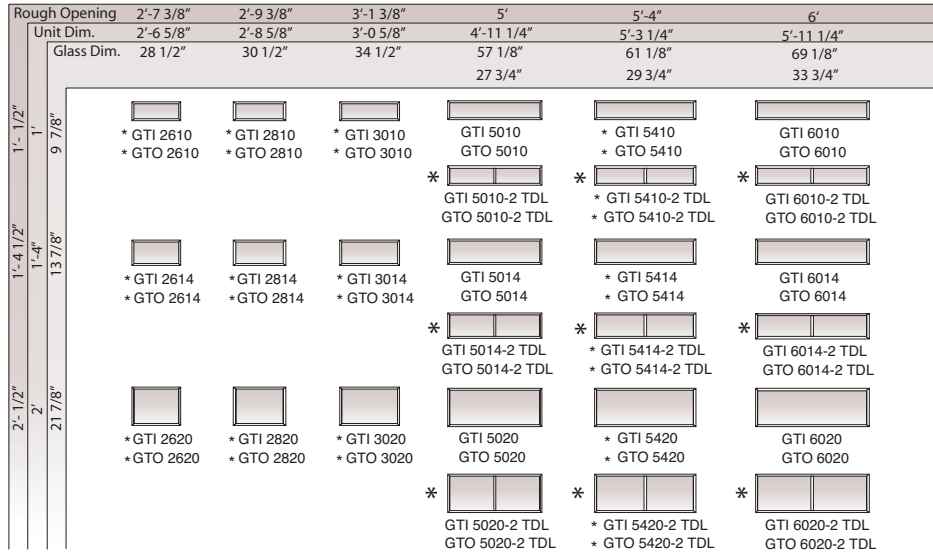

LEGEND

1. Rough Opening Width = Unit Dim. Width + 3/4"
2. Rough Opening Height = Unit Dim. Height + 1/2"
3. Glass Option: Clear / Inner Grille / Art Glass
4. Custom Size Also Available by Special Order
5. Standard transom are equal size glass
6. Special size or special Lite pattern must be by special order
7. GTI = Inswing
8. GTO = Outswing
9. GTV = Vented Sidelight

For 3 Panel Units

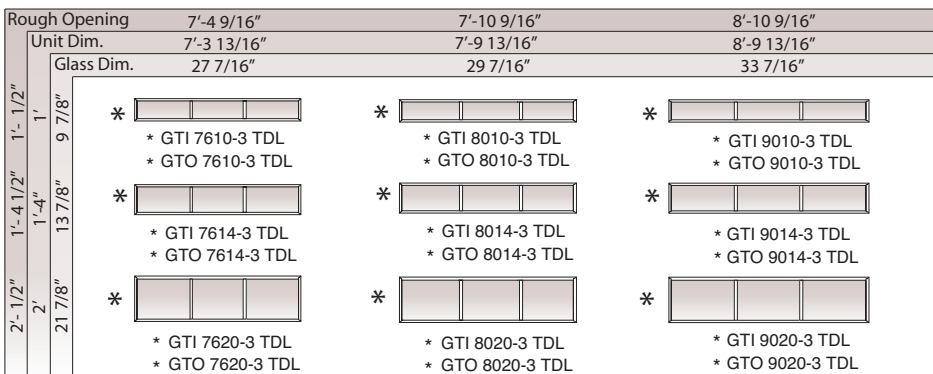

Note: Transom grid patterns may not align with certain doors. Please call for assistance with transom selection.

*All transoms with divided lites are True Divided Lite (TDL). Grille between glass (GBG) and simulated divided lite (SDL) options are also available.

For Vented Sidelight

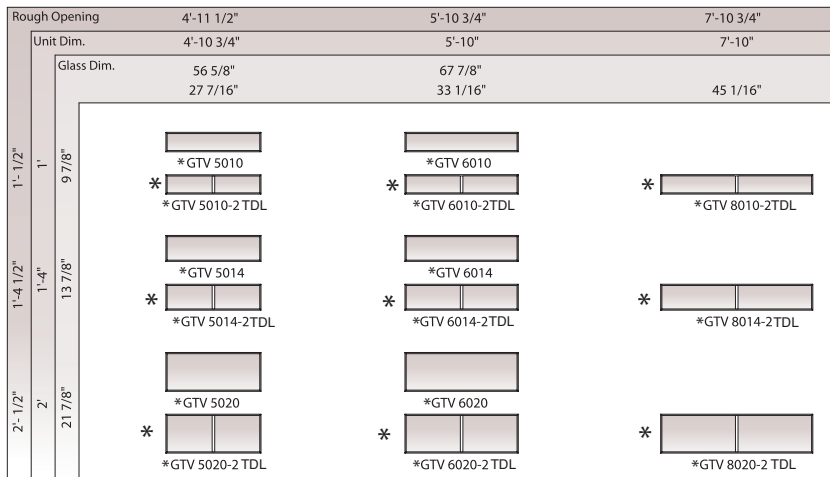

**For Florida Building Code Approval, please see: http://www.floridabuilding.org/pr/pr_app_srch.aspx. For Texas Department of Insurance Approval, see: <http://www.tdi.state.tx.us/wind/prod/indexdr.html>. For Dade County Approval, see: http://www.miamidade.gov/building/pc-search_app.asp?



HINGED TEST RESULTS

Hinged Non-Impact

Full Lite Inswing Non-Impact AAMA Test Results

Product specification	Design Pressure Rating	Structure Performance (psf)	Water Resistance (psf)	Air Infiltration (cfm/ft ²)	AAMA 101 Standard
3068, 30611, L/R/S	DP40	+90/-90	6.0	0.09	SHD-CLASS R-PG40 144" X 83"
6068, 60611, LP/PR/SL/RS/SS	DP40	+90/-90	6.0		
12068, 120611, SLPS/SPRS	DP40	+90/-90	6.0		
3080, L/R/S	DP40	+75/-75	7.5	0.02	SHD-CLASS R-PG50 144" X 96"
6080, LP/PR/SL/RS/SS	DP40	+75/-75	7.5		
12080, SLPS/SPRS	DP40	+75/-75	7.5		

3/4 Lite Inswing - Non-Impact AAMA Results

Product specification	Design Pressure Rating	Structure Performance (psf)	Water Resistance (psf)	Air Infiltration (cfm/ft ²)	AAMA 101 Standard
12080 SLPS	DP50	+75/-75	7.5	0.006	SHD-class R-PG50 143 1/8"x95 1/2"
120611 SLPS	DP50	+75/-75	7.5	0.1	SHD-class R-PG50 143 1/8"x82 1/2"

Full Lite Outswing - Non-Impact AAMA Test Results

Product specification	Design Pressure Rating	Structure Performance (psf)	Water Resistance (psf)	Air Infiltration (cfm/ft ²)	AAMA 101 Standard
3068, 30611, L/R/S	DP65	+97.5/-97.5	9.75	0.19	SHD-CLASS R-PG70 143 1/4" X 82 1/2"
	DP70	+105/-105	10.5		
6060, 60611, LP/PR/SL/RS/SS	DP65	+97.5/-97.5	9.75		
	DP70	+105/-105	10.5		
12068, 120611, SLPS/SPRS	DP65	+97.5/-97.5	9.75		
	DP70	+105/-105	10.5		
3080, L/R/S	DP65	+97.5/-97.5	9.75	0.14	SHD-CLASS R-PG70 143 1/4" X 95 3/4"
	DP70	+105/-105	10.5		
6080, LP/PR/SL/RS/SS	DP65	+97.5/-97.5	9.75		
	DP70	+105/-105	10.5		
12080, SLPS/SPRS	DP65	+97.5/-97.5	9.75		
	DP70	+105/-105	10.5		

3/4 Lite Outswing - Non-Impact AAMA Test Results

Product Specification	Design Pressure Rating	Structure Performance (psf)	Water Resistance (psf)	Air Infiltration (cfm/ft ²)	AAMA 101 Standard
12080 SLPS	DP50	+75 / -75	7.5	0.001	SHD-class R-PG50 143 1/8"x95 1/2"
12068,SLPS	DP50	+75 / -75	7.5	0.001	SHD-class R-PG50 143 1/8"x79 1/2"

Vented Sidelight - Non-Impact AAMA Results

Product specification	Design Pressure Rating	Structure Performance (psf)	Water Resistance (psf)	Air Infiltration (cfm/ft ²)	AAMA 101 Standard
8068, LLPR	DP30	+45/-45	4.5	0.02	HGD-LC30 94" X 83"

Energy Performance Rating - Non-Impact Hinged

Door Type	Door Style	Glass Type	Energy Star Climate Zones				U-Factor	SHGC	VT
			North	North Central	South	South Central			
Hinged Non-Impact	Full Lite	LoE ³ 366	*	*	*	*	0.25	0.14	0.30
		LoE ³ 340	*	*	*	*	0.25	0.09	0.18
		LoE ³ Blinds	-	-	-	-	0.27	0.25	0.28
	3/4 Lite	LoE ³ 366	*	*	*	*	0.25	0.09	0.20

Sound Transmission Class - Non-Impact Hinged

Product Specification	STC	OITC	Product Specification	STC	OITC
3080 Outswing Pemko ADA Sill (1" Special Glass)	35	28	6068, LP Outswing (0.625" Standard Non-Impact Glass)	29	25
3080 Outswing Extended Pemko ADA Sill (5/8" Standard Glass)	31	27	6080 Outswing Pemko ADA Sill (1" Special Non-Impact Glass)	30	27
3080 Inswing Endura ADA Sill (1" Special Glass)	31	26	6080 Inswing Endura ADA Sill (1" Special Non-Impact Glass)	29	24

Hinged Transoms

Transom Test Results - Non Impact

Product specification	Design Pressure Rating	Structure Performance (psf)	Water Resistance (psf)	Air Infiltration (cfm/ft ²)	AAMA 101 Standard	Type
GTI 6020	DP80	+120/-120	12.00	0.01	TR-LC80 71 1/4" X 24"	Inswing
GTI 12020 (with mullion)	DP75	+120/-120	11.25	0.01	TR-R75 145 3/8" X 24"	
GTO 6020	DP80	+120/-120	12.00	0.01	TR-LC80 71 1/4" X 24"	Outswing
GTO 12020 (with mullion)	DP75	+120/-120	11.25	0.01	TR-R75 145 3/8" X 24"	

Transom Test Results - Non Impact

Product specification	Design Pressure Rating	Structure Performance (psf)	Water Resistance (psf)	Air Infiltration (cfm/ft ²)	Test Standard	Type
GTI/GTO 6020	DP80	+120/-120	12.00	0.01	TAS 201/202/203	Inswing & Outswing
GTI/GTO 12020 (with mullion)	DP80	+120/-120	12.00	0.01	TAS 201/202/204	

Hinged Impact

Full Lite - Impact & Cycle Testing Performance

Product specification	Max. Testing Dimension	Design Pressure Rating	Structure Performance (psf)	Water Resistance (PSF)	Air Infiltration (cfm/ft ²)	Test Standard
Inswing SLPS (OXXO)	11'11" X 6'11"	DP50	+75/-75	7.5	0.03	ASTM E1886/ASTM E1996
Outswing SLPS (OXXO)	11'11" X 6'11"	DP50	+75/-75	7.5	0.01	ASTM E1886/ASTM E1996
		DP70	+105/-105	10.5		
Outswing SLP (OXX)	9'1" X 6'11"	DP70	+105/-105	10.5	0.003	TAS201/202/203
Inswing SLPS (OXXO)	11'11" X 8'0"	DP50 Structural Only	+75/-75	2.9	0.002	ASTM E1886/ASTM E1996
Inswing SLP (OXX)	9'1" X 8'0"	DP50 Structural Only	+75/-75	3.75	0.12	TAS201/202/203
Outswing SLPS (OXXO)	11'11" X 8'0"	DP50	+75/-75	7.5	0.003	ASTM E1886/ASTM E1996
		DP70	+105/-105	10.5		
Outswing SLP (OXX)	9'1" X 8'0"	DP50	+75/-75	7.5	0.01	TAS201/202/203
Outswing SLPL (OXXO)	12'1" X 8'0"	DP70	+105/-105	10.5	0.002	TAS201/202/203

3/4 Lite Panel - Impact & Cycle Testing Performance

Product specification	Max. Testing Dimension	Design Pressure Rating	Structure Performance (psf)	Water Resistance (PSF)	Air Infiltration (cfm/ft ²)	Test Standard
Inswing SLP (OXX)	8'10" X 8'0"	DP50 Structural Only	+75/-75	3.75	0.003	ASTM E1886/ASTM E1996
Outswing SLP (OXX)	8'10" X 8'0"	DP50	+75/-75	7.5	0.001	ASTM E1886/ASTM E1996
Outswing SLPS (OXXO)	11'11" X 6'8"	DP50	+75/-75	7.5	0.001	ASTM E1886/ASTM E1996
Inswing SLPS (OXXO)	11'11" X 6'11"	DP50	+75/-75	7.5	0.1	ASTM E1886/ASTM E1996

Energy Performance Rating - Impact Hinged

Door Type	Door Style	Glass Type	Energy Star Climate Zones				U-Factor	SHGC	VT
			North	North Central	South	South Central			
Hinged Impact	Full Lite	LoE ³ 366	*	*	*	*	0.24	0.13	0.30
		LoE ³ 340	*	*	*	*	0.24	0.09	0.18
	3/4 Lite	LoE ³ 366	*	*	*	*	0.29	0.09	0.20

Sound Transmission Class - Impact Hinged

Product Specification	STC	OITC
3080, L Outswing (1" Double Laminated Glass)	35	30
6068, LP Inswing (1" Standard Impact Glass)	34	30
6068, LP Outswing (1" Standard Impact Glass)	34	30

**For Florida Building Code Approval, please see: http://www.floridabuilding.org/pr/pr_app_srch.aspx.

For Texas Department of Insurance Approval, see: <http://www.tdi.state.tx.us/wind/prod/indexdr.html>.

For Dade County Approval, see: http://www.miamidade.gov/building/pc-search_app.asp?



FOLDING SERIES

The Neuma Folding Door System provides a clean, elegant solution for joining the interior of your home to the outdoors and is available for openings up to 12' wide by 8' tall. With the ability to span various size openings, and multiple configuration and customization options to meet the demands of your project, a Neuma Doors folding door system is the perfect choice.

Energy Efficient

A wide range of glass options provide you with high level comfort and energy savings year-round. The Neuma Doors Folding Door System comes standard with LoE³ 366 glass for optimal energy efficiency.

Built to Last

Our Impact Rated Glass is designed specifically to meet strict requirements for impact, air, water, and structural wind loads. The structural performance and durable hardware of all systems ensures that you can enjoy your folding patio door for years to come.

Security

Multipoint locking systems are standard on all folding door systems to give you security and peace of mind. Top and bottom flush bolts also come standard on the folding door system for added strength and security.

Design Features

Panels feature composite edging and Hydroshield Technology for advanced moisture protection and maximum durability to withstand the elements. Durable fiberglass skin will not rust, dent, split or rot, ensuring that your family can enjoy your folding door for years to come. For your convenience, the folding door system features a "daily door," a single hinged unit that can be used for daily entry without having to activate all of the panels in the unit. Smooth white interior and exterior finish can be painted to fit any palette and match any style.





FEATURES

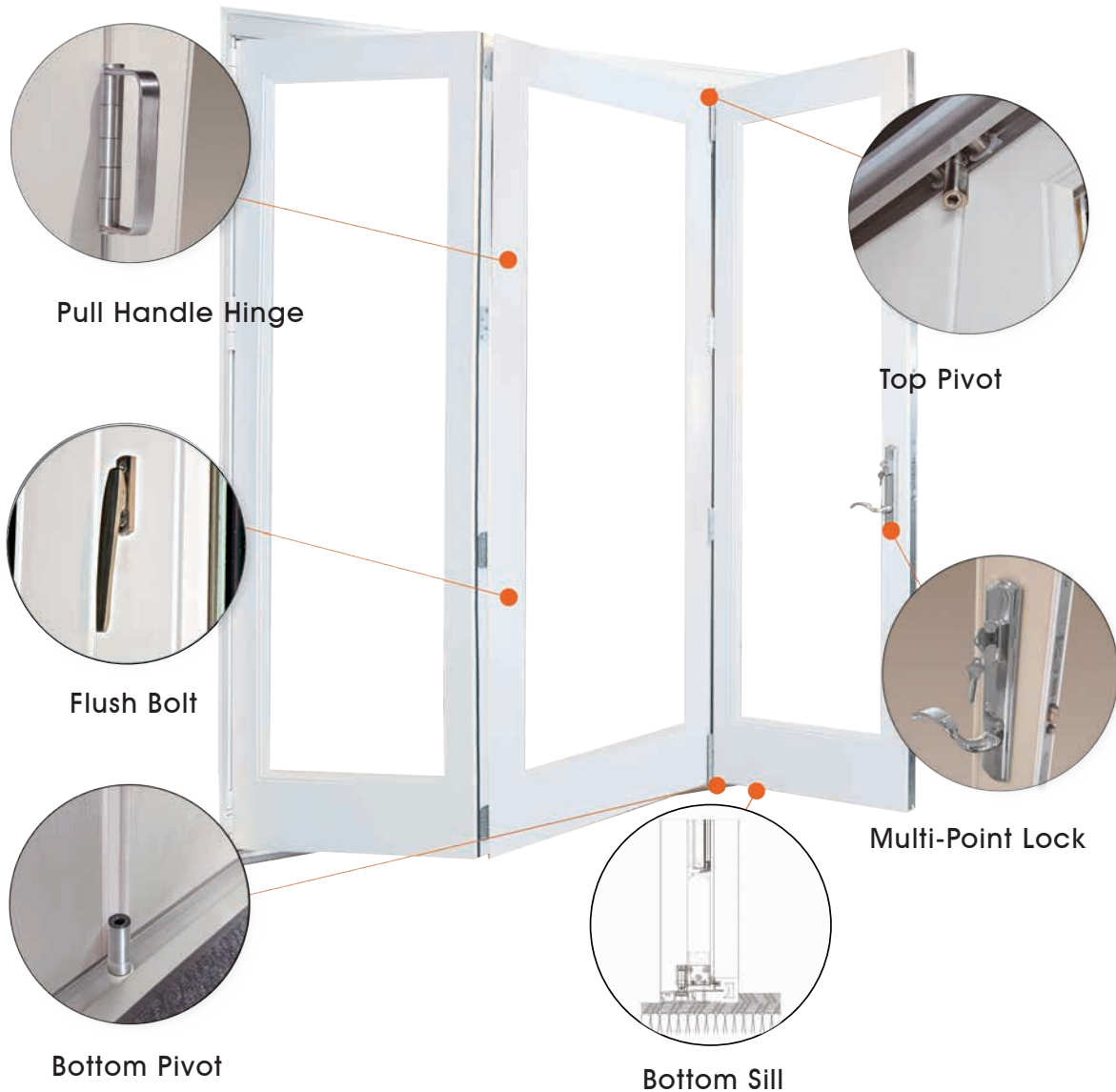

- Complete system with frame and integrated hardware
- Features a “daily door” - a hinged single door that can be used for daily entry on certain configurations
- Fiberglass panels with a composite edging and Hydroshield Technology for advanced moisture protection and maximum durability
- Frames made of waterproof composite material
- Durable fiberglass skins will not rust, dent, split or rot

- Durable CFC free polyurethane foam panel core
- Standard LoE³ 366 insulated glass and removable glazing bead for easy glass replacement
- Features smooth white interior and exterior finish
- Available for openings up to 12' wide by 8' tall
- Energy Star certified in all 50 states
- 4-9/16" Frame

CONFIGURATIONS

2 Panel Folding Unit



3 Panel Folding Unit



4 Panel Folding Unit



Two Panel

Three Panel

Four Panel

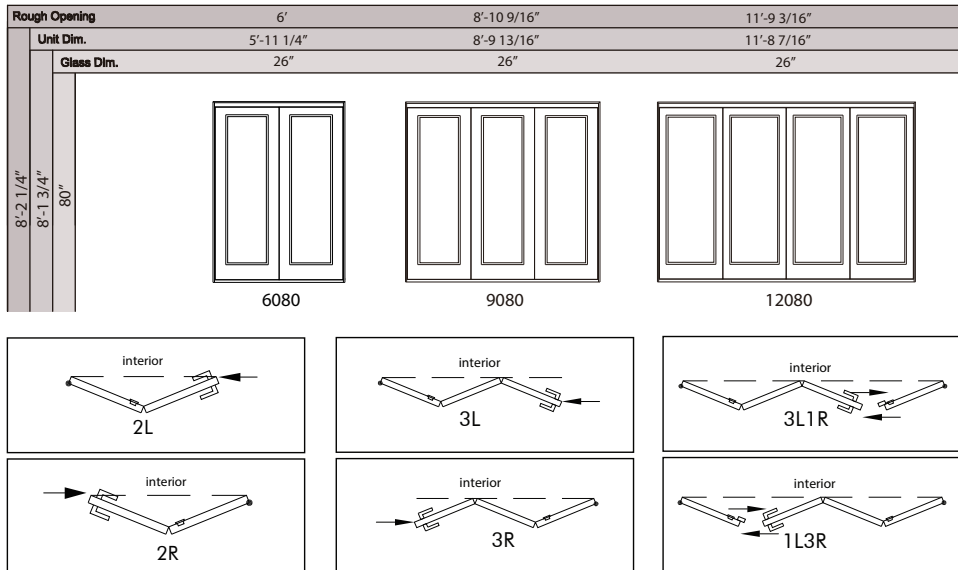

Folding Doors - Impact & Cycle Testing Performance

Product Specification	Max. Testing Dimension	Design Pressure Rating	Structure Performance (psf)	Water Resistance (psf)	Air Infiltration (cfm/ft ²)	Test Standard
Outswing PRBJ(1L3R)	11'8" X 8'2"	DP60	+90/-90	9.0	0.005	ASTM E 1886/ASTM E 1996

Folding Doors Outswing - AAMA Test Result (Full Lite Panel)

Product Specification	Design Pressure Rating	Structure Performance (psf)	Water Resistance (psf)	Air Infiltration (cfm/ft ²)	AAMA101 Standard
9080, 3L/3R	DP60	+90/-90	9.0	0.005	SP-CLASS R-PG60
12080, 3L1R/1L3R	DP60	+90/-90	9.0	0.005	140 7/16" X 97 3/4"

Folding Doors Outswing - AAMA Test Result (Full Lite Panel)

Door Type	Door Style	Glass Type	Energy Star Climate Zones				U-Factor	SHGC	VT
			North	North Central	South	South Central			
Folding Non-Impact	Full Lite	LoE ³ 366	*	*	*	*	0.27	0.16	0.36
Folding Impact	Full Lite	LoE ³ 366	*	*	*	*	0.26	0.16	0.35

GLIDING SERIES

- Panels and frames made of fiberglass and composite material with Hydroshield Technology for advanced moisture protection and maximum durability
- Durable fiberglass skins will not rust, dent, split or rot
- ENERGY STAR certified in all 50 States
- Durable CFC-free polyurethane foam panel core
- Advanced interlocking seal design
- Monorail track for reduced friction
- Adjustable stainless steel tandem rollers
- Removable glazing bead for easy glass replacement
- Door heights available in 6'-8", 6'-11", 7'-10" and 8'-0" sizes
- Frames available in 4-9/16" or 6-9/16" sizes
- Thresholds include drainage systems to channel water away from doors
- Paintable smooth surface or unstained woodgrain are standard with pre-finished options available
- Doors tested for structural stability, water infiltration, air infiltration, forced entry, sound transimission, and energy efficiency





FEATURES

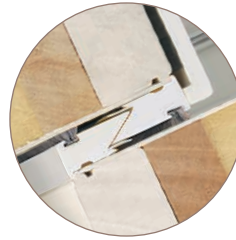

1 Advanced Interlocking Seal Design



2 Retractable Screen



3 Co-extruded glazing bead



4 Weep Hole



5 Bottom Wind Stopper

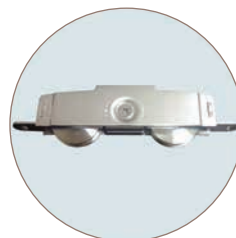

6 Adjustable Stainless Steel Tandem Rollers

Advanced Interlocking Seal Design

Provides superior weather protection.

Optional Retractable Screens

Attractive option that keeps the screen hidden from view when not in use.

Co-extruded glazing bead

Designed for easy glass replacement.

Weep Holes

Allow water to drain away from the door while keeping dirt and dust out.

Bottom Wind Stopper

Provides extra weather protection and helps prevent air leakage.

Adjustable Stainless Steel Tandem Rollers

Designed for smooth effortless operation.



SELECT AND BUILD YOUR OWN GLIDING UNIT



Standard Features Chart

Gliding Door - Standard Features	Gliding 6'8" & 6'11"	Gliding Impact 6'8" & 6'11"	Gliding 7'10" & 8'0"	Gliding Impact 7'10" & 8'0"
Smooth White Interior Finish	•	•	•	•
Smooth White Exterior Finish	•	•	•	•
Standard Handlest in White, Dark Brown, Gold Brass or Satin Nickel	•		•	
HPVD Handleset in Satin Nickel or Gold Brass		•		•
White Sill	•	•	•	•
Single Point Lock	•			
Multi Point Lock		•	•	•
4 9/16" Jamb Width	•	•	•	•
LoE ³ 366 Glass	•		•	
LoE ³ 366 Laminated Impact Glass		•		•

Gliding Options

Be creative in building a custom large view gliding unit design. Build a multi-panel gliding unit on your standard double gliding unit with our impact tested mull post system.

Combo Options



Mull Kits

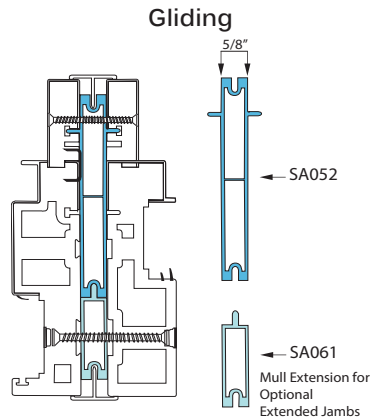

Grille Options

Grilles are used to visually divide the glass area of the door for added architectural detail. Grilles Between Glass (GBG) are aluminum grilles sealed between the two layers of glass and offer an attractive low maintenance option. Simulated Divided Lites (SDL) are applied directly to the glass surface and offer a more traditional appearance.

Neuma offers standard 10, 12, 15, and 18 grille patterns as well as custom grille patterns available through special order.

Available Grille Pattern

6'8 & 6'11 Height

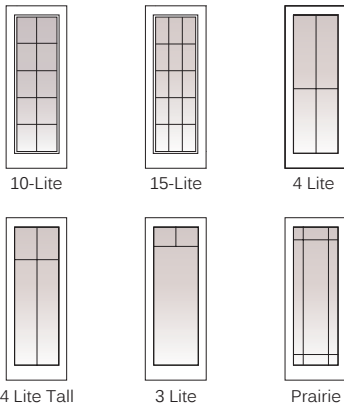

8' Height

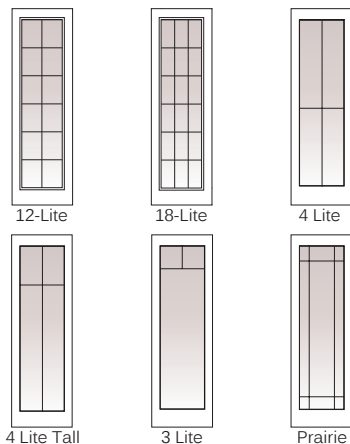









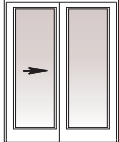
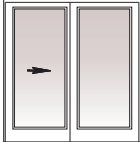
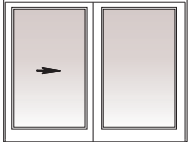

GLIDING UNITS AND DIMENSIONS

Full Lite

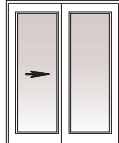
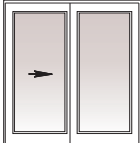
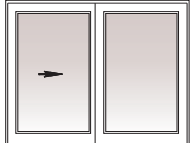
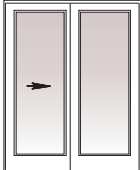
Single Panel Units

Two Panel Units

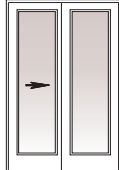
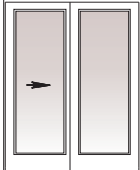
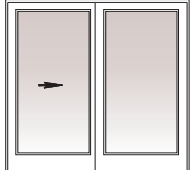
Rough Opening	2'-8 1/4"	3'-2 1/4"	4'-2 1/4"	5'	6'	8'
Unit Dim.	2'-7 1/2"	3'-1 1/2"	4'-1 1/2"	4'-11 1/4"	5'-11 1/4"	7'-11 1/4"
Glass Dim.	21 5/16"	27 5/16"	38"	21 5/16"	27 5/16"	38"
6'-8"						
	DGP 2668 (O)	DGP 3068 (O)	DGP 4068 (O)	DGP 5068 (X O)	DGP 6068 (X O)	DGP 8068 (X O)
6'-11"						
	DGP 26611 (O)	DGP 30611 (O)	DGP 40611 (O)	DGP 50611 (X O)	DGP 60611 (X O)	DGP 80611 (X O)
7'-9 3/4"						
				DGP 60710 (X O)		
8'-0"						
	DGP 2680 (O)	DGP 3080 (O)	DGP 4080 (O)	DGP 5080 (X O)	DGP 6080 (X O)	DGP 8080 (X O)

Available Grille Patterns

6'8" & 6'11" Height

8' Height

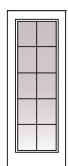

10-Lite

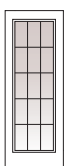

15-Lite

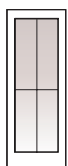

4 Lite

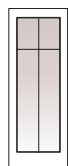

4 Lite Tall

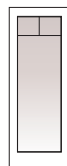

3 Lite

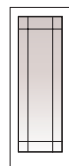

Prairie

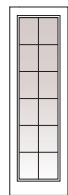

12-Lite

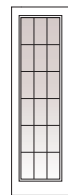

18-Lite

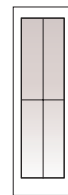

4 Lite



4 Lite Tall

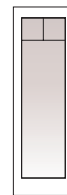

3 Lite



Prairie

Full Lite

Three Panels Units

Four Panel Units

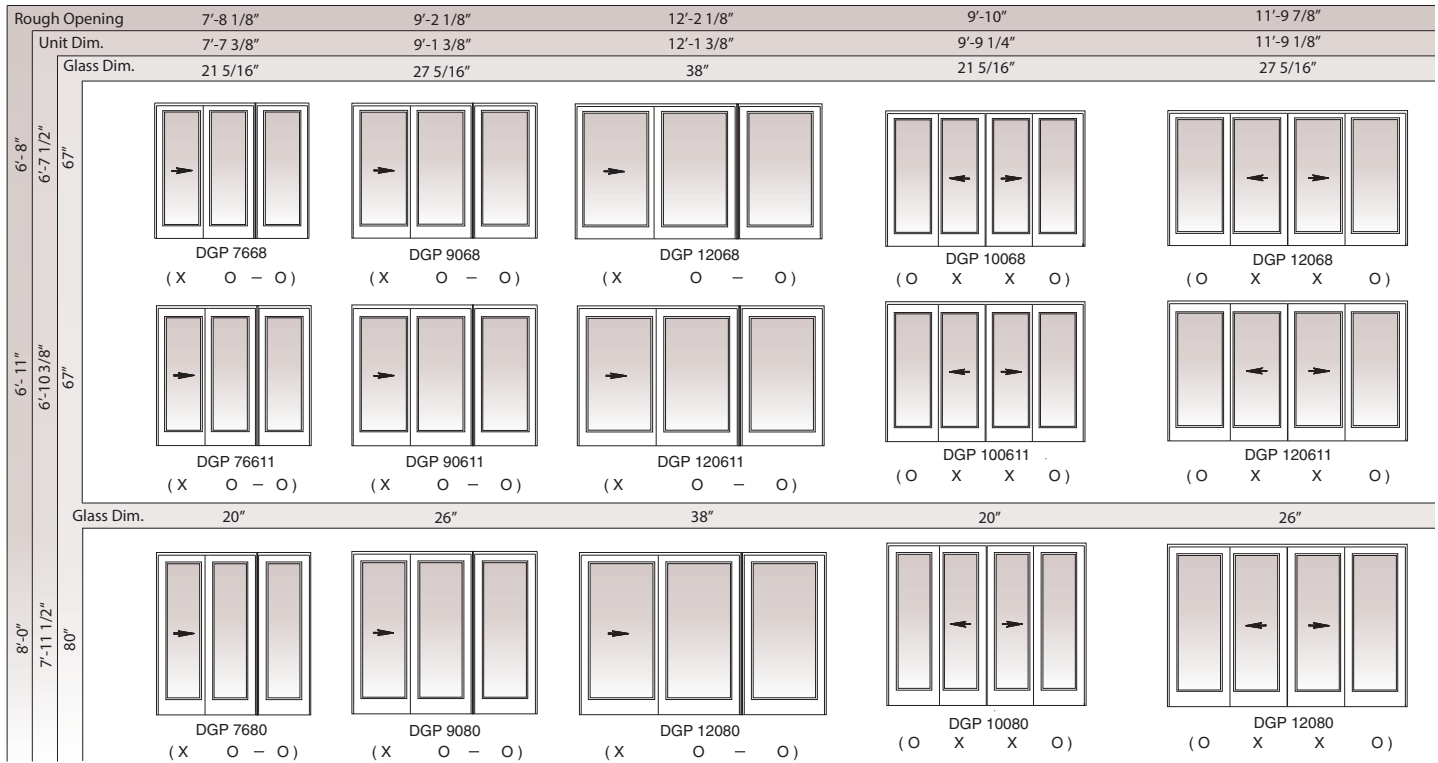

Reference	One Panel	Two Panels	
Handing Call-out	O	OX	XO
Reference Code	S	SR	LS

Reference	Three Panels	
Handing Call-out	XO-O	O-OX
Reference Code	LSS	SSR

Reference	Three Panels	
Handing Call-out	OX-O	O-XO
Reference Code	SRS	SLS

Reference	Four Panels
Handing Call-out	OXXO
Reference Code	SPLS

Mull Kits

Gliding

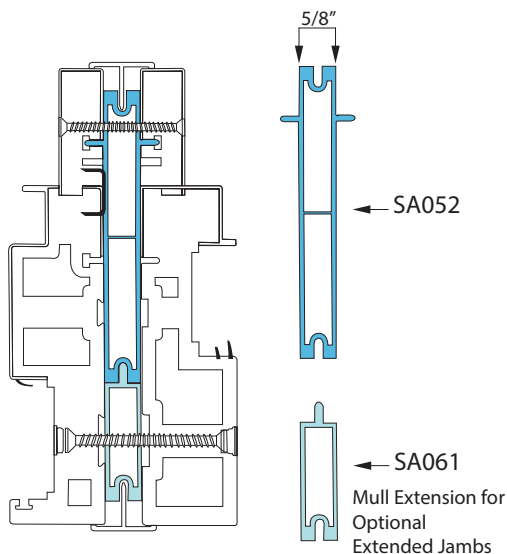

When creating a custom configuration by combining panels and door units, add 5/8" to the unit dimension to allow for the width of the aluminum mull.

LEGEND

- Handing from exterior view
- Doors are not reversible
- Retractable screen available as an option

O = Fixed Panel
 X = Active Panel
 S = Stationary Panel
 DGP = Gliding Door

Gliding Panel Specifications

Gliding Patio Doors - Full Lite

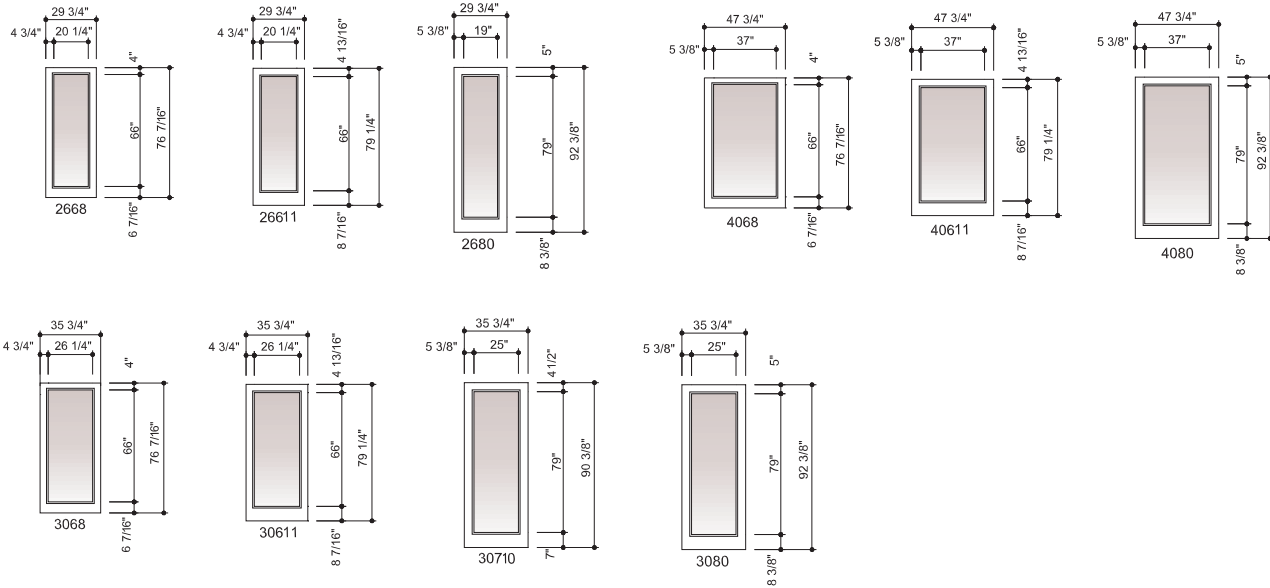

Gliding Patio Doors - 3/4 Lite

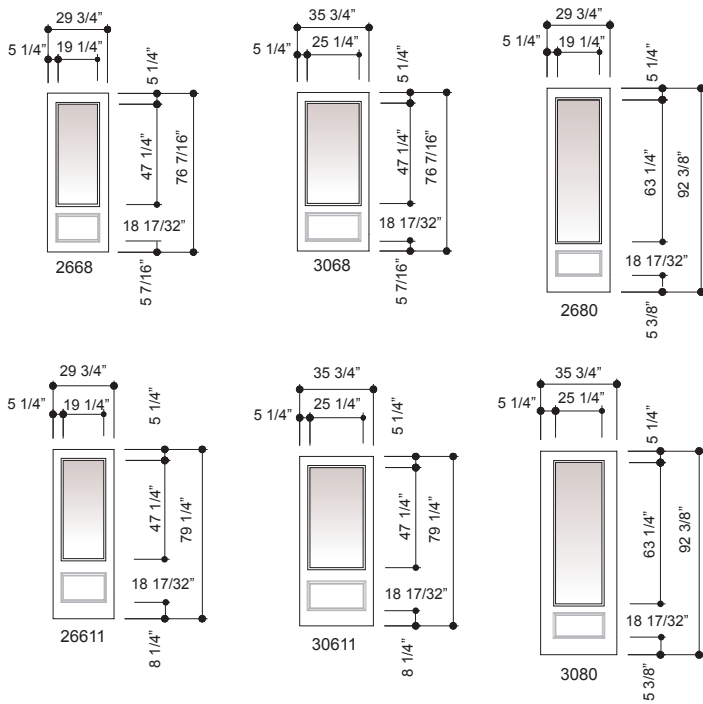



3/4 Lite Gliding Handing

Single Panel Units

Two Panel Units

Rough Opening	2'-8 1/4"	3'-2 1/4"	5'	6'
Unit Dim.	2'-7 1/2"	3'-1 1/2"	4'-11 1/4"	5'-11 1/4"
Glass Dim.	20"	26"	20"	26"
6'-8" / 6'-7 1/2" / 48"	DGP 2668 (O)	DGP 3068 (O)	DGP 5068 (X O)	DGP 6068 (X O)
6'-11" / 6'-10 3/8" / 48"	DGP 26611 (O)	DGP 30611 (O)	DGP 50611 (X O)	DGP 60611 (X O)
8'-0" / 7'-11 1/2" / 64"	DGP 2680 (O)	DGP 3080 (O)	DGP 5080 (X O)	DGP 6080 (X O)

LEGEND

- Handing from exterior view
- Doors are not reversible
- Retractable screen available as an option

O = Fixed Panel
 X = Active Panel
 S = Stationary Panel
 DGP = Gliding Door

3 Panel Units

4 Panel Units

Rough Opening	7'-8 1/8"	9'-2 1/8"	9'-10"	11'-9 7/8"
Unit Dim.	7'-7 3/8"	9'-1 3/8"	9'-9 1/4"	11'-9 1/8"
Glass Dim.	20"	26"	20"	26"
6'-8" / 6'-7 1/2" / 48"	DGP 7668 (X O - O)	DGP 9068 (X O - O)	DGP 10068 (O X X O)	DGP 12068 (O X X O)
6'-11" / 6'-10 3/8" / 48"	DGP 76611 (X O - O)	DGP 90611 (X O - O)	DGP 100611 (O X X O)	DGP 120611 (O X X O)
8'-0" / 7'-11 1/2" / 64"	DGP 7680 (X O - O)	DGP 9080 (X O - O)	DGP 10080 (O X X O)	DGP 12080 (O X X O)

Transoms For Gliding Doors

For Single Panel Units

For 2 Panel Units

Rough Opening	2'-8 1/4"	3'-2 1/4"	4'-2 1/4"	5'	6'	8'
Unit Dim.	2'-7 1/2"	3'-1 1/2"	4'-1 1/2"	4'-11 1/4"	5'-11 1/4"	7'-11 1/4"
Glass Dim.	29 7/16"	35 7/16"	47 7/16"	57 1/8"	69 1/8"	7'-11 1/4"
				27 3/4"	33 3/4"	45 3/4"
1'-1/2"						
1'-4 1/2"						
2'-1/2"						

For 3 Panel Units

Rough Opening	7'-8 1/8"	9'-2 1/8"	12'-2 1/8"
Unit Dim.	7'-7 3/8"	9'-1 3/8"	12'-1 3/8"
Glass Dim.	28 5/8"	34 5/8"	46 5/8"
1'-1/2"			
1'-4 1/2"			
2'-1/2"			



For 4 Panel Units

Rough Opening	9'-10"	11'-9 7/8"
Unit Dim.	9'-9 1/4"	11'-9 1/8"
Glass Dim.	27 1/2"	33 1/2"
1'-1/2"		
1'-4 1/2"		
2'-1/2"		

*For all product testing approval numbers and information, please visit :

<http://www.neumadoors.com/resource>

*For Florida Building Code Approval, please see :

http://www.floridabuilding.org/pr/pr_app_srch.aspx

*For Texas Department of Insurance Approval, see :

<http://www.tdi.state.tx.us/wind/prod/indexdr.html>

*For Dade County Approval, see :

http://www.miamidade.gov/building/pc-search_app.asp?

Gliding Transoms Test Results

Transom - Non Impact

Product specification	Design Pressure Rating	Structure Performance (psf)	Water Resistance (psf)	Air Infiltration (cfm/ft²)	AAMA 101 Standard	Type
GTG 6020	DP80	+120/-120	12.00	0.01	TR-LC80 71 1/4" X 24"	Gliding
GTG 12020 (with mullion)	DP75	+120/-120	11.25	0.01	TR-R75 145 3/8" X 24"	

Transom - Impact

Product specification	Design Pressure Rating	Structure Performance (psf)	Water Resistance (psf)	Air Infiltration (cfm/ft²)	Test Standard	Type
GTG 6020	DP80	+120/-120	12.00	0.01	TAS 201/202/203	Gliding
GTG 12020 (with mullion)	DP80	+120/-120	12.00	0.01	TAS 201/202/204	

GLIDING TEST RESULTS

Gliding Non-Impact

Full Lite Gliding - Non-Impact AAMA Test Result

Product specification	Design Pressure Rating	Structure Performance (psf)	Water Resistance (psf)	Air Infiltration (cfm/ft ²)	AAMA 101 Standard
6068,60611, LS/SR(XO/OX)	DP50	+75/-75	7.5	0.028	SGD-Class R-PG50 142" x 83"
9068, 90611, SSR/LSS (OOX/XOO)	DP50	+75/-75	7.5		
12068, 120611, SPLS (OXXO)	DP50	+75/-75	7.5		
8068, 80611, LS/SR (XO/OX)	DP50	+75/-75	7.5	0.007	SGD-Class R-PG50 146" x 83"
12068, 120611, SRS (OXO)	DP50	+75/-75	7.5		
6080, LS/SR (XO/OX)	DP50	+75/-75	7.5	0.074	SGD-Class R-PG50 142" x 96"
9080, SSR/LSS (OOX/XOO)	DP50	+75/-75	7.5		
12080, SPLS (OXXO)	DP50	+75/-75	7.5		
8080, LS/SR (XO/OX)	DP50	+75/-75	7.5	0.028	SGD-Class R-PG50 146" x 96"
12080, SRS (OXO)	DP50	+75/-75	7.5		

Energy Performance Rating - Gliding Non-impact

Door Type	Door Style	Glass Type	Energy Star Climate Zones				U-Factor	SHGC	VT
			North	North Central	South	South Central			
Gliding Non-Impact	Full Lite	LoE ³ 366	*	*	*	*	0.26	0.18	0.40
		LoE ³ 340	*	*	*	*	0.27	0.12	0.24

Sound Transmission Class - Non-impact

Product Specification	STC	OITC
6068, LS Gliding (1" Special Non-impact Glass)	30	25
6068, LS Gliding (0.625" Standard Non-impact Glass)	27	23

Sound Transmission Class - Impact Gliding

Product Specification	STC	OITC
6068, LS Gliding (1" Standard Laminated Glass)	32	29
6068, LS Gliding (1" Double Laminated Glass)	33	30

Gliding Impact

Full Lite - Impact & Cycle Testing Performance

Product specification	Max. Testing Dimension	Design Pressure Rating	Structure Performance (psf)	Water Resistance (PSF)	Air Infiltration (cfm/ft ²)	Test Standard
SRS(OXO)	12'1" X 6'11"	DP50	+75/-75	7.5	0.072	ASTM E1886/ASTM E1996
SRS(OXO)	12'1" X 6'11"	DP50	+75/-75	7.5	0.011	TAS201/202/203
SPLS(OXXO)	11'9" X 6'11"	DP50	+75/-75	7.5	0.01	ASTM E1886/ASTM E1996
SPLS(OXXO)	11'9" X 6'11"	DP50	+75/-75	7.5	0.16	TAS201/202/203
SRS(OXO)	12'1" X 8'0"	DP50	+75/-75	7.5	0.057	ASTM E1886/ASTM E1996
SRS(OXO)	12'1" X 8'0"	DP50	+75/-75	7.5	0.23	TAS201/202/203
SPLS(OXXO)	11'9" X 8'0"	DP50	+75/-75	7.5	0.02	ASTM E1886/ASTM E1996
SPLS(OXXO)	11'9" X 8'0"	DP50	+75/-75	7.5	0.02	TAS201/202/203

Full Lite - Impact & Cycle Testing Performance

Door Type	Door Style	Glass Type	Energy Star Climate Zones				U-Factor	SHGC	VT
			North	North Central	South	South Central			
Gliding Impact	Full Lite	LoE ³ 366	*	*	*	*	0.26	0.17	0.39
		LoE ³ 340	*	*	*	*	0.26	0.11	0.24



BYPASS

GLIDING SERIES

The Neuma Bypass Gliding Patio Doors are a modern, polished option designed for large openings and available with various finish, glass, and configuration customizations. Unlike hinged doors, they do not require internal or external space to operate, giving you freedom to decorate and style your home without concern about your patio door getting in the way. A bypass door with full lite panels modernizes your space while infusing your space with natural light.

Glass Options

Neuma Bypass Gliding Patio Doors come standard with energy efficient LoE³ 366 glass to keep your home protected from variations in outside temperature while maintaining light and visibility. We also offer impact rated glass options designed specifically to meet requirements for impact, air, water, and structural wind loads. The structural performance and hardware of all systems ensures that your family can delight in your bypass patio door for years to come.

Security

Multipoint locking systems are standard on all 8' bypass gliding door systems to give you peace of mind. All 6'8" and 6'11" bypass gliding doors come standard with single point lock systems, with optional multipoint locks available for added strength and security.

Design and Customization

The bypass door panels feature extended views and ample natural light when closed. When open, they offer a sleek and unobtrusive transition to your outdoor space. Composite edging and Hydroshield Technology combine for advanced moisture protection and maximum durability to withstand the elements. Durable fiberglass skin will not rust, dent, split or rot, ensuring that your family can enjoy your bypass patio door for years to come. HPVD coated handle sets are available in Gold Brass or Satin Nickel to provide additional protection from the elements. The standard smooth white interior and exterior finish can be painted to complement your home's color palette and match any style.





FEATURES

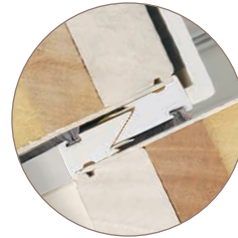

1 Advanced Interlocking Seal Design



2 Retractable Screen



3 Co-extruded glazing bead



4 Weep Hole



5 Bottom Wind Stopper

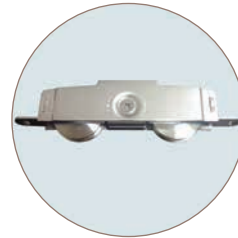

6 Adjustable Stainless Steel Tandem Rollers

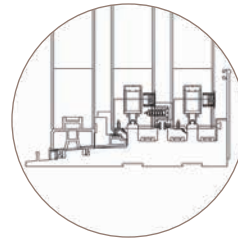

7 Composite One-piece Sill

- Complete fiberglass multi-slide door system with composite frame and integrated Hydroshield Technology for advanced weather protection
- High performance composite jambs prevent warping, splitting and rotting
- High-Impact fiberglass door skins resist corrosion, rotting or cracking
- Waterproof composite stiles and rails prevent water absorption
- Designed for openings up to 8'10" wide by 8' tall
- Continuous composite header and bottom track sill system
- Standard high-performance LoE³ 366 glass
- DP 50 rated
- Impact option available
- 8-3/16" Frame



BYPASS GLIDING

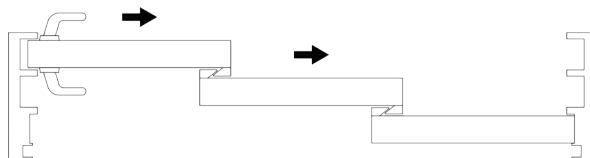
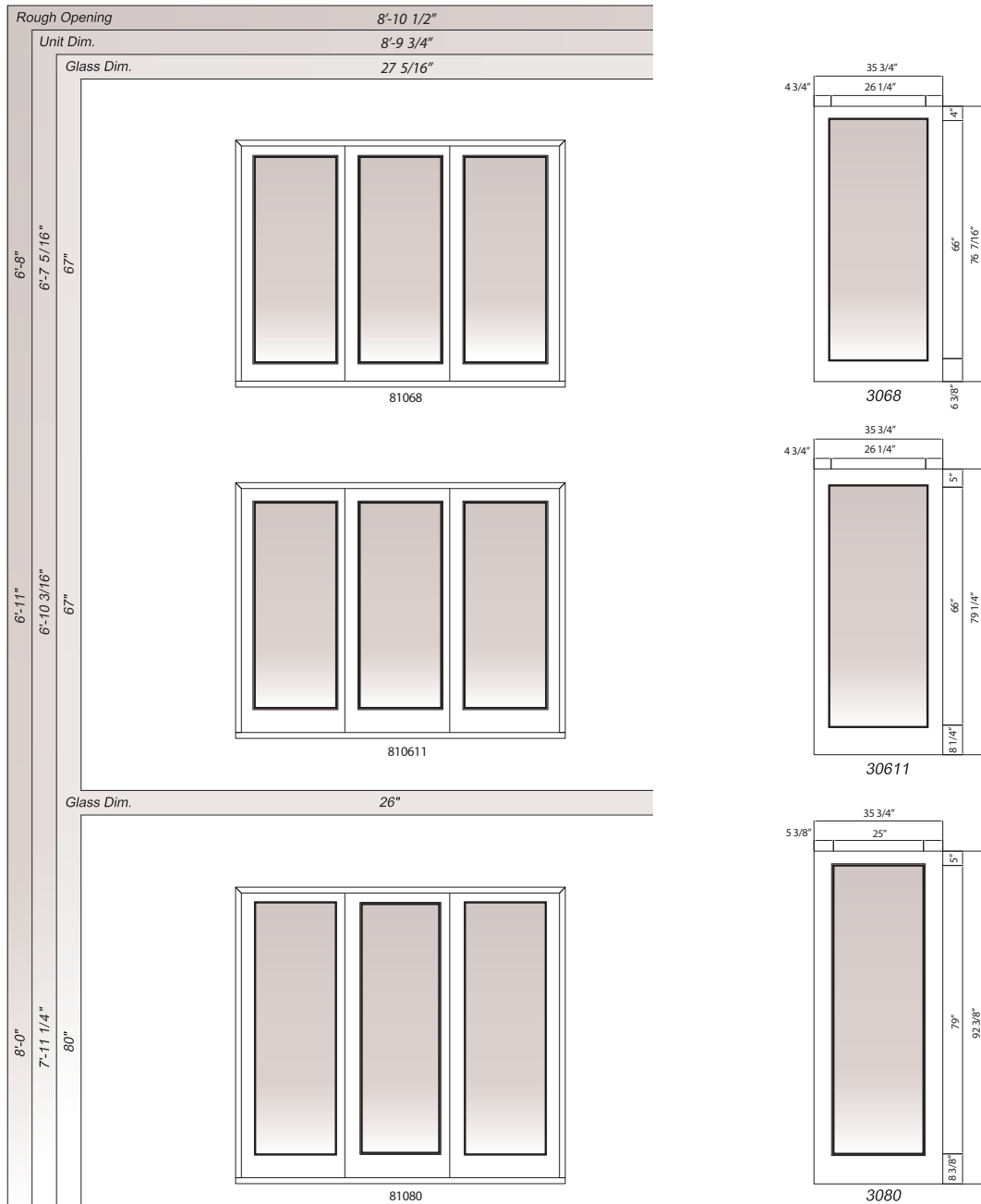

LEGEND

- Handing from exterior view
- Doors are not reversible
- Retractable screen available as an option

- O = Fixed Panel
- X = Active Panel
- S = Stationary Panel
- DGP= Gliding Door

Bypass Gliding - Non-Impact AAMA Test Results

Product specification	Design Pressure Rating	Structure Performance (psf)	Water Resistance (PSF)	Air Infiltration (cfm/ft ²)	AAMA 101 Standard
LPS (XXO)_no sill riser	DP50	+75/-75	6.0	<0.01	SD-CLASS R-PG50 106" x 82"
LPS (XXO)_with sill riser	DP50	+75/-75	7.5		
LPS (XXO)_no sill riser	DP50	+75/-75	6.0	<0.01	SD-CLASS R-PG50 106" x 95.5"
LPS (XXO)_with sill riser	DP50	+75/-75	7.5		

Bypass Gliding - Impact & Cycle Testing Performance

Product specification	Max. Testing Dimension	Design Pressure Rating	Structure Performance (psf)	Water Resistance (PSF)	Air Infiltration (cfm/ft ²)	Test Standard
LPS (XXO)_no sill riser	106" x 82"	DP50	+75/-75	6.0	<0.1	ASTM E1886 / ASTM E1996
LPS (XXO)_with sill riser	106" x 82"	DP50	+75/-75	7.5		
LPS (OXXO)_no sill riser	106" x 95.5"	DP50	+75/-75	6.0	<0.1	ASTM E1886 / ASTM E1996
LPS (OXO)_with sill riser	106" x 95.5"	DP50	+75/-75	7.5		

Energy Performance Rating - For Gliding Patio Doors Impact

Door Type	Door Style	Glass Type	Energy Star Climate Zones				U-Factor	SHGC	VT
			North	North Central	South	South Central			
Bypass Gliding Non-Impact	Full Lite	LoE ³ 366	*	*	*	*	0.26	0.18	0.40
		LoE ³ 340	*	*	*	*	0.27	0.12	0.24
		LoE ³ Blinds	-	-	-	-	0.29	0.36	0.41
Bypass Gliding Impact	Full Lite	LoE ³ 366	*	*	*	*	0.26	0.17	0.39
		LoE ³ 340	*	*	*	*	0.26	0.11	0.24

*For all product testing approval numbers and information, please visit <http://www.neumadoors.com/resource>

**For Florida Building Code Approval, please see http://www.floridabuilding.org/pr/pr_app_srch.aspx. For Texas Department of Insurance Approval, see <http://www.tdi.state.tx.us/wind/prod/indexdr.html>. For Dade County Approval, see http://www.miamidade.gov/building/pc-search_app.asp?







Transom & Sidelight Options

Enhance the look of your door and brighten your space with transoms and sidelights.

Transom windows above the door add charm and character and allow light to pass while maintaining your privacy. Neuma Doors offers transoms in a variety of sizes and styles for both hinged and gliding door styles. With an array of divided light patterns, you can design the transom to compliment the style of your home and patio door.

- * Net Jamb dimensions are 5-3/4" and 7-3/4"
- * Shipped unstacked (not mullled)
- * Transoms are tested separately from door unit.

Sidelights visually open up the doorway and increase the ambient light and access to the outdoor views. Choose from our expansive offering of sidelights for both hinged and gliding doors. For added fresh air ventilation, select the Vented Sidelight option which features fully operable sidelights with multi-point locks and stationary screens.

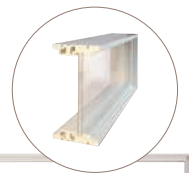



BUILD YOUR OWN COMBINATION

Typical Sidelight and Transom Combinations

Combination with mull kit

Gliding Series

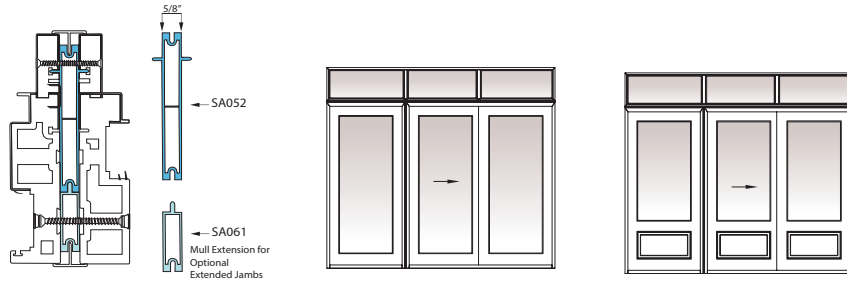

Hinged Series

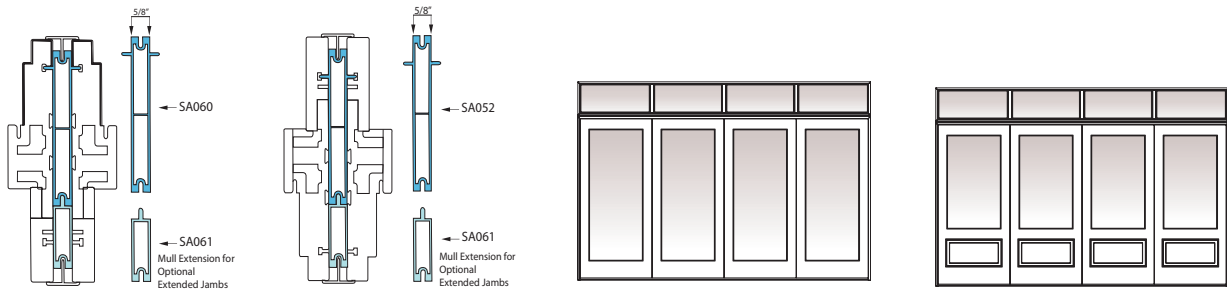

Combination with mull post and continuous sill

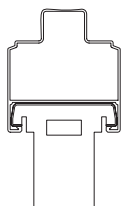
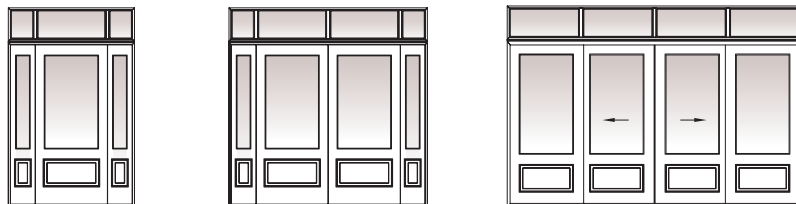
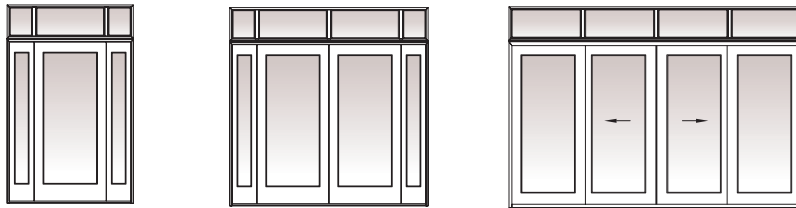

Hinged Units are available only on inswings

Gliding Units are available in OXXO 12ft Units

Transom Mull Kit

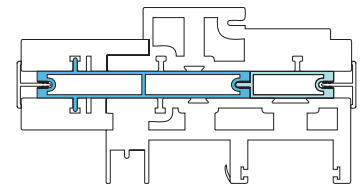

Gliding

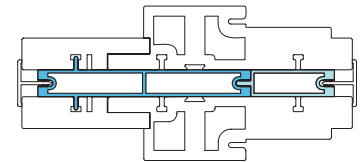

Inswing Hinged

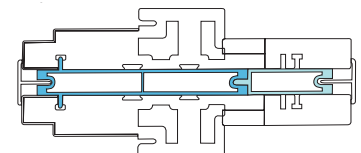

Outswing Hinged



GLAZING OPTIONS

Standard Insulated Glass

The insulating effect of your doors has a direct impact on how your rooms feel. Our glazing options provide not only a beautiful entry, but also a reliable barrier against the heat and damaging rays of the hot sun. Each double pane LoE³ glass option provides Argon gas filled insulation to prevent the transfer of heat, keeping heat in during the winter and out during the summer. Available LoE³ glass options are designed to reflect ultraviolet light, not only keeping interiors cooler or warmer, but also protecting interior furnishings from fading. Warm edge spacers help to keep the panes at the correct distance apart while reducing heat flow and preventing condensation.

Standard LoE³ 366 glass, Ultimate performance glass

An unprecedented 3 layers of silver and Argon gas fill results in a clear coating that blocks the solar heat gain, reflects heat and lets the light stream in giving you the ideal balance of solar control and high visibility. LoE³ 366 is also the perfect choice for cold weather climates, helping to keep higher interior glass temperatures in cold weather, dramatically improving any thermal discomfort from the cold outside air.

Optional LoE³ 340 glass, Glare back at the sun

The solution to solar glare and thermal discomfort starts with LoE³ 340 glass with Argon gas fill. Uncontrolled sunlight can be an offender by bringing thermal discomfort and creating visual glare. LoE³ 340 glass provides a great combination of aesthetic appeal along with energy savings and indoor comfort.

Optional Insulated Laminated Impact Glass

Laminated glazing offers the greatest protection from life's storms. Neuma Doors impact glazing gives you and your home the best level of security and assurance. During windstorms and hurricanes, wind borne wreckage can impact windows, with gusting, pervasive winds to follow. The broken glass fragments adhere to the interlayer and maintain the home's defense from the wind, rain and forced entry. Laminated impact glass adds security and cannot be cut from one side only.



Grilles Between Glass (GBG)

Flat white 3/4" grilles between two layers of glass are available in 10, 12, 15 and 18 standard lite patterns or can be customized by special order.



Simulated Divided Lites (SDL)

Simulated divided lites give you the classic look and feel of a true divided lite door. 100% composite SDL bars are fixed directly to the glass and can be ordered with or without Grilles Between the Glass. 7/8" SDL bars are available for 5/8", 3/4" and 1" glaze options in both smooth and woodgrain textures in finishes to match the door's finish.

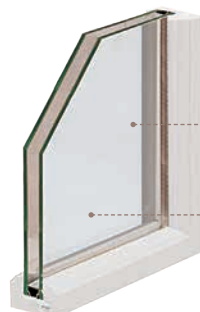
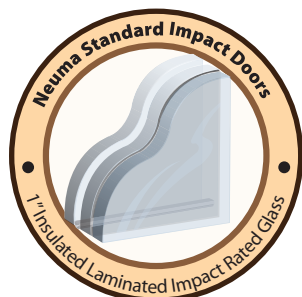

Argon filled units for energy efficiency

LoE³ 366 glass





BLINDS

Between The Glass

Available in either Clear or LoE options, Blinds Between the Glass feature a cordless tilt, raise and lower operation. The mini blinds are sealed between 2 panes of glass within the door and provide several key benefits.

CLEANLINESS

No accumulation of dust or allergens.

SAFETY

No hanging cords or operators and provide maximum safety protection for children and pets.

PRIVACY AND LIGHT CONTROL

Flexibility to adjust to your desired level of privacy and sunlight. Raise the blinds completely for maximum sunlight and an unobstructed view or close completely for total privacy.

DURABILITY

Blinds stay protected from damage behind the glass and away from curious little fingers and paws.

LoE BLINDS

The LoE Blinds Between the Glass option are built with LoE glass that improves the energy efficiency of the door. The one operator control system provides raise, lower AND tilt options in one sleek operator design.

*Blinds not available in 3/4 lite panels



FINISH OPTIONS

Pre-pigmented or pre-stained colors



Unstained

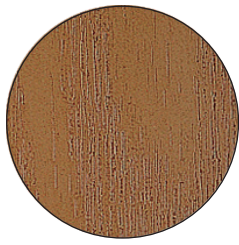

Golden Oak

























Medium Oak



Dark Mahogany



White Wood Grain

	Standard Finish. Standard finish on all of Neuma's Patio Doors.		Pre-finished combinations available for Neuma's Patio Door Units. Neuma customers can have their patio doors customized with the following pre-finished combinations. There is an additional 8-10 week turnaround time on all orders. This option saves time and money by eliminating the need for finishing on-site. * The smooth white is not a finished face.								
Color Code	002	300	3N2	3MF	3M2	3RF	3R2	3KF	3K2	003	302
Interior	*  Smooth White	 Unstained	 Unstained	 Dark Mahogany	 Dark Mahogany	 Golden Oak	 Golden Oak	 Medium Oak	 Medium Oak	 White Wood Grain	 White Wood Grain
Exterior	*  Smooth White	 Unstained	*  Smooth White	 Dark Mahogany	*  Smooth White	 Golden Oak	*  Smooth White	 Medium Oak	*  Smooth White	 White Wood Grain	*  Smooth White



PAINT FINISH COLORS

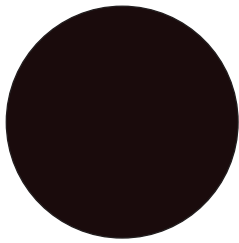

Bronze

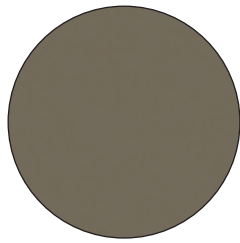

Brainstorm Bronze

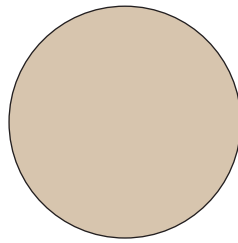

Kilim Beige

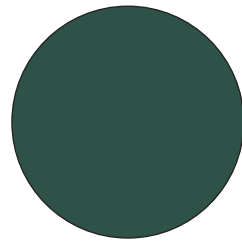

Hunt Club

*** Colors and finishes in this publication are not actual representations.

Color Code	2A2	2C2	2E2	2B2
Interior	 Bronze	 Brainstorm Bronze	 Kilim Beige	 Hunt Club
Exterior	 Bronze	 Brainstorm Bronze	 Kilim Beige	 Hunt Club

Neuma customers can have their patio doors customized with our standard paint finishes. The paint finish program is only applicable to smooth white doors and includes the painted finish on both the interior and exterior sides of the door. Paint finish on only one side of the door or a paint color other than one of the standard colors of the door is a special order and may be subject to a minimum order quantity.

There is an additional 2 week turnaround time for all painted finish orders. This option saves time and money by eliminating the need for finishing on site.

The paint finishes contain solar reflective pigments that protect the door from excessive heat absorption.



HARDWARE

Standard Hinged Hardware

- Single Point Lock Systems are standard on 6'8" and 6'11" doors
- Multi Point Lock Systems are standard on 7'6" & 8'0" doors
- Handle Sets are available in your choice of color and style

Hardware Options

- Multi Point Lock Systems are optional on 6'-8", 6'-11" doors.
- HPVD (High Physical Vapor Deposition) coated handle sets are available in the Royal Style handle set in Gold Brass or Satin Nickel colors. The HPVD coating provides additional protection in harsh environments. HPVD coating requires proper maintenance. **see maintenance guide for proper care instructions.**



Tiffany Series

Royal Series



Standard lock system

Optional Multi Point Lock System for 6'8, 6'11"

Standard on our 7'6" & 8'0" doors



Standard Single 6'8" & 6'11"

Precision-engineered entry spring latch and dead bolt lock design standard on Neuma's 6'8" and 6'11" door units.



Optional Multi-Point Lock 6'8" & 6'11"

Stainless steel strike plates provide excellent corrosion resistance, enhanced performance, smooth operation, and the best security value.



Standard Multi Point Lock System for 7'6" & 8'0"

Neuma's 7'6" & 8'0" doors come standard with our multi-point lock system. Unique to our 7'6" & 8'0" hinged door units, it features a 3 hook lock and keeper design to maintain the highest level of security.

*Muti-lock plate and strike plates are available in gold brass and satin nickel finishes only.



Standard Handleset Choices

Standard Gliding Hardware

- Single Point Lock Systems are standard on 6'8" and 6'11" doors
- Multi Point Lock Systems are standard on 7'10" and 8'0" doors
- White Sills are standard on all doors
- Handle Sets are available in your choice of color

Hardware Options

- Multi Point Lock Systems are optional on 6'-8" and 6'-11" doors
- HPVD (High Physical Vapor Deposition) coated handle sets are available in Gold Brass or Satin Nickel colors. The HPVD coating provides additional protection in harsh environments. HPVD coating requires proper maintenance. **See maintenance guide for proper care instructions.**
- Straight exterior handle in Satin Nickel finish set is available as an option (straight handle set not compatible with blinds between glass option)



Gold Brass Satin Nickel Dark Brown White
(Powder Coated)

*Straight Handleset Option

- Exterior option only
- Not available with mini blind option
- Only available with a Satin Nickel finish

Standard Single Point Lock System for 6'8", 6'11"

Optional Multi Point Lock System for 6'8", 6'11"

Standard on our 7'-10" & 8'-0" doors



Standard Single 6'8" & 6'11"

Precision-engineered single mortise hook-style lock and keeper come standard on Neuma's 6'8" and 6'11" door units.



Optional Multi-Point Lock 6'8" & 6'11"

Stainless steel strike plates provide excellent corrosion resistance, enhanced performance, smooth operation, and the best security value.



Standard Multi Point Lock System for 7'6" & 8'0"

Neuma's 7'-10" & 8'0" doors come standard with our multi-point lock system. Unique to our 7'-10" & 8'0" gliding door units, it features a 3 hook lock and keeper design to maintain the highest level of security.

*Muti-lock plate and strike plates are available in gold brass and satin nickel finishes only.



ADDITIONAL OPTIONS

Screens

- Our retractable screens can be used in most of our patio door Systems: Inswing, Outswing, Center Hinged and Gliding.
- Available for single and double door units.
- Screenshot with individual lock plunger to open each door with ease. No magnets.
- Screen option not available for any unit with ADA sill.



Screen doors provide the perfect solution when you want maximum airflow and light infiltration while keeping bugs out of your home. On temperate days, screen doors allow you to enjoy the outdoor weather without the hassle of pesky insects. Enjoy the sunlight, the summer breeze, and the sounds of nature of your outside space while maintaining an indoor space free of unwelcome critters.

Our classic screen door sits in its own track and slides out of the way when the door is in use. The screen can be closed when the main door is open to provide airflow and passage of light while deterring outdoor pests. When pushed aside, the screen door sits in front of the stationary panel to allow uninhibited use of the main door.

For a low-profile, modern look try our vanishing screen. When engaged, the screen covers the door opening to allow fresh air and sunlight into your home.

When you are ready to disengage the screen, it retracts completely, rolling into its canister. The vanishing screen is perfect if you want the flexibility of a screen door without the commitment to the look of a more traditional style screen door.



Retractable Screen



Standard Gliding Screen

Brickmold Options



Smooth White

Brickmold fills the gap between the exterior facing of a building and the doorframe and serves as a visual border between the masonry of the home and the door. Available in a variety of profiles to complement any architectural style, brickmold adds charm and curb appeal to the home.



Unstained Woodgrain

Whether for new construction or renovation, Neuma Doors allows you to customize your new door by selecting one of our brickmold options. Neuma Doors offers brickmold in unstained woodgrain or smooth white texture. Our brickmold is both stainable and paintable, allowing you to match your new brickmold with existing shutters, siding, or trim on your home and make a stunning impact.

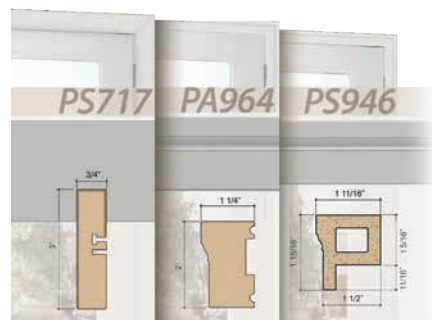

PRODUCT DETAILS CHART

Feature	Full Lite Hinged Doors	3/4 Lite Hinged Doors	Vented Sidelight Doors	Folding Doors	Full Lite Gliding Doors	3/4 Lite Gliding Doors	Bypass Gliding Doors
Operation	Inswing, Outswing	Inswing, Outswing	Inswing	Outswing	Gliding	Gliding	Gliding
Skin Material	Fiberglass	Fiberglass	Fiberglass	Fiberglass	Fiberglass	Fiberglass	Fiberglass
Skin Texture	Oak Grain or Smooth	Mahogany Grain or Smooth	Oak Grain or Smooth	Smooth	Oak Grain or Smooth	Mahogany Grain or Smooth	Smooth
Exterior Finish	Stained, Painted, Unstained Woodgrain, White Woodgrain or Smooth White	Stained, Painted, Unstained Woodgrain, White Woodgrain or Smooth White	Stained, Painted, Unstained Woodgrain, White Woodgrain or Smooth White	Painted or Smooth White	Stained, Painted, Unstained Woodgrain, White Woodgrain or Smooth White	Stained, Painted, Unstained Woodgrain, White Woodgrain or Smooth White	Painted or Smooth White
Interior Finish	Stained, Painted, Unstained Woodgrain, White Woodgrain or Smooth White	Stained, Painted, Unstained Woodgrain, White Woodgrain or Smooth White	Stained, Painted, Unstained Woodgrain, White Woodgrain or Smooth White	Painted or Smooth White	Stained, Painted, Unstained Woodgrain, White Woodgrain or Smooth White	Stained, Painted, Unstained Woodgrain, White Woodgrain or Smooth White	Painted or Smooth White
Frame Material	Composite	Composite	Composite	Composite	Composite	Composite	Composite
Height Options	6'8", 6'11", 7'6", 8'0"	6'8", 6'11", 8'0"	6'8"	8'0"	6'8", 6'11", 7'10", 8'0"	6'8", 6'11", 8'0"	6'8", 6'11", 8'0"
Width Options	2'2-1/16", 2'6-5/8", 2'8-5/8", 3'0-5/8"	2'6-5/8", 2'8-5/8", 3'0-5/8"	5'-10", 7'-10" overall unit widths	5' 11- 1/4 ", 8' 9-13/16", 11' 8-7/16" overall unit width	2'7-1/2", 3'1-1/2", 4'-1-1/2"	2'7-1/2", 3'1-1/2"	8'-9 7/8" overall unit width
Panel Options	1,2 or 3 panels	1,2 or 3 panels	3 or 4 panels	2,3 or 4 panels	1,2,3 or 4 panels	1,2,3 or 4 panels	3 panels
Sidelite Width Options	1'0", 1'2", 1'11-1/4"	1'2"	Included with unit	Not Available	Not Available	Not Available	Not Available
Glass Options	LoE ³ 366, LoE ³ 340, Textured, Clear Blinds, LoE Blinds, SDL, GBG	LoE ³ 366, LoE ³ 340, Textured, SDL, GBG	LoE ³ 366, LoE ³ 340, Textured, Clear Blinds, LoE Blinds, SDL, GBG	LoE ³ 366	LoE ³ 366, LoE ³ 340, Textured, Clear Blinds, LoE Blinds, SDL, GBG	LoE ³ 366, LoE ³ 340, Textured, SDL, GBG	LoE ³ 366, LoE ³ 340, Textured, Clear Blinds, LoE Blinds, SDL, GBG
Sill Width Options	4-9/16", 6-9/16"	4-9/16", 6-9/16"	4-9/16", 6-9/16"	4-9/16"	4-9/16", 6-9/16"	4-9/16", 6-9/16"	8-3/16"
Multi-Point Lock	Standard on Impact, 7"6" and 8' doors, Optional on 6'8", 6'11" doors	Standard on Impact and 8' doors, Optional on 6'8", 6'11" doors	Standard for sidelites, Optional for operable door(s)	Standard	Standard on Impact, 7'10" and 8' doors, Optional on 6'8", 6'11" doors	Standard on Impact and 8' doors, Optional on 6'8", 6'11" doors	Standard
Screens *Option not available for units with ADA Sill	Vanishing Screen Available	Vanishing Screen Available	Standard for sidelites, Optional for operable door(s)	Not Available	Standard and Vanishing Screen Available	Standard and Vanishing Screen Available	Not Available
*Residential Limited Warranty	Limited Lifetime	Limited Lifetime	Limited Lifetime	Limited Lifetime	Limited Lifetime	Limited Lifetime	Limited Lifetime
*Multi-Family Commercial Warranty	10 Years	10 Years	10 Years	10 Years	10 Years	10 Years	10 Years

* Warranty Exclusions apply. For full warranty information, exclusions, limitations, and warranty service request procedures, please visit <http://www.neumadoors.com/pdf/warranty.pdf>

DOOR DESIGN SPECIFICATIONS

Hinged Doors

Standard Features

- Standard hinged door units come with smooth white interior and exterior or unstained woodgrain interior and exterior, LoE³ 366 glass, stainless steel hinges and 4-9/16" jambs.
- Single-point locks standard on 6'8" and 6'11" height doors.
- Multi-Point locks standard on all 7'6" and 8'0" height doors.
- All units that measure over 9' in width are shipped knock-down (KD).

General Information

- Gold brass and dark brown handle sets come with matching sills and brass strike plates. Satin nickel and white handle sets come with an aluminum sill and strike plates.
- Unfinished hinged doors come with a matching paintable/stainable sill.
- Extended 6-9/16" jamb options available.

Folding Doors

Standard Features

- Standard folding door units come with smooth white interior and exterior, LoE³ 366 glass, stainless steel hinges and 4-9/16" jambs.
- Standard multi-point locks
- Standard top and bottom stainless steel flush bolts and pull handle
- Continuous header and sill system
- All folding units shipped knock-down (KD)

Gliding Doors

Standard Features

- Standard gliding door units come with smooth white interior and exterior or unstained woodgrain interior and exterior, LoE³ 366 glass and 4-9/16" jambs.
- Single-point locks standard on all 6'8" and 6'11" height doors.
- Multi-point locks standard on all 7'10" and 8'0" height doors.
- All units that measure over 9' in width are shipped knock-down (KD).

General Information

- Unfinished gliding doors come with a matching, paintable sill and stainable. All other gliding doors come with a white sill.
- Extended 6-9/16" jamb options available.

Bypass Gliding Doors

Standard Features

- Standard bypass folding door units come with smooth white interior and exterior, and LoE³ 366 glass
- Standard single point locks on all 6'8" and 6'11" height doors
- Standard multi-point locks on all 8'0" height door
- Continuous header and sill system
- All bypass gliding units are shipped knock-down (KD)
- 8-3/16" jamb
- Standard sill includes sill riser

Impact Doors

Impact Rated Doors

- Impact door options come standard with smooth white interior and exterior or unstained woodgrain interior and exterior, LoE³ 366 glass, stainless steel hinges, 4-9/16" jambs Multi-point locks and HPVD coated handle sets.
- HPVD coated handle and lock set are only available in the Royal Series style in choice of satin nickel or gold brass finishes.

HVHZ Impact

- HVHZ impact rated units are tested under TAS 201, 202, 203.
- HVHZ impact rated doors are assembled with reinforced fiberglass panels.

Vented Sidelight

Standard Features

- Vented Sidelight standard units come with smooth white interior and exterior or unstained woodgrain interior and exterior, LoE³ 366 glass, stainless steel hinges, and 4-9/19" jambs.
- Standard dead bolt and latch on the main door and multi-point locks on the sidelights are standard.
- Fixed screens on the sidelights are standard.

General Information

- Multi-point locks on the main door are available as an option.
- Vented sidelights are available in 6'8" height only.
- Vented sidelight units available as inswing door only.

Transoms

- Transoms are available to compliment many door configurations.
- Available for both hinged and gliding doors
- Available net jamb dimensions are 5-3/4" and 7-3/4"
- Transoms are tested independently from the door unit.
- Transoms are not factory mulled to the door unit. It is the sole responsibility of the installer to follow proper installation instructions.
- Transoms with grid patterns are available. It is the sole responsibility of the distributor to provide correct order information for proper grid alignment between the transom and the door.

Blinds

- Mini blinds available in Clear and LoE options.
- Mini blinds option is not available with impact glass, or 3/4 lite panel options.

Screens

- Screen options not available for any door unit with ADA Sill.

HANDING GUIDE



Single Doors

Exterior View

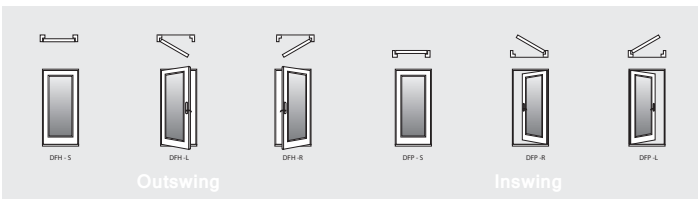

Double Hinged Doors (2 panel)

Exterior View

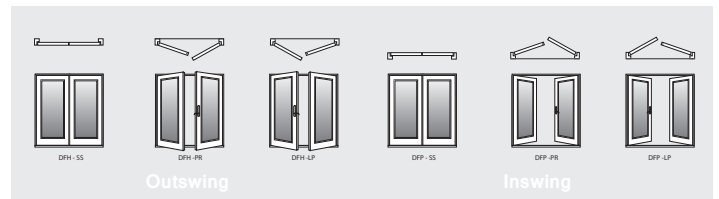

Center Hinged Doors (2 panel)

Exterior View

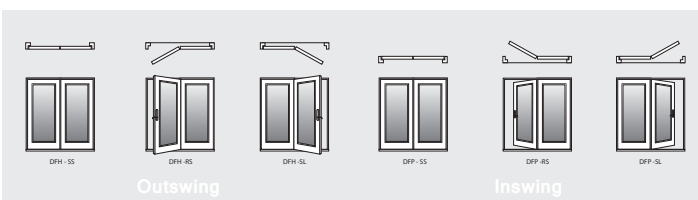

Center Hinged Doors (3 panel)

Exterior View

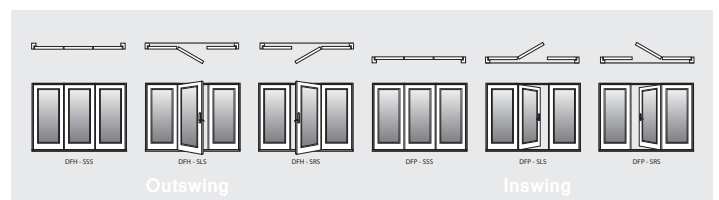



Inswing Vented Sidelight - 6'8" Retro Fit Exterior View

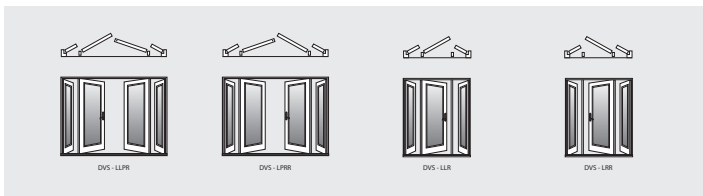

Folding Door Series

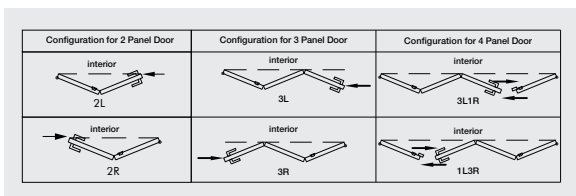

Gliding Doors

Exterior View

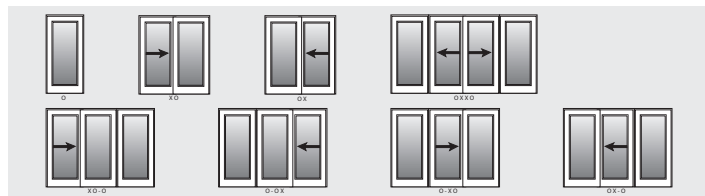

Bypass Gliding Doors

Exterior View

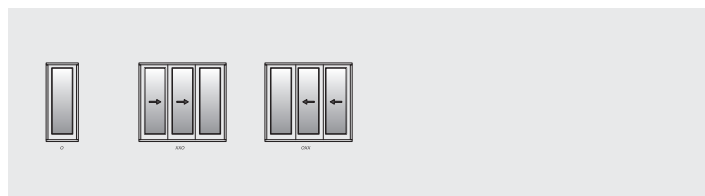

PAINTING GUIDE



MATERIALS NEEDED

1. Scotch Brite Pad (Fine) or 320-400 grit sandpaper.
2. For water-based application: Acrylic primer/acrylic latex-based exterior grade paint.

*** We recommend using “Sherwin Williams PrimeRX[®] Peel Bonding Primer” with compatible acrylic-latex paint for optimal paint adhesion.

STEP 1: SURFACE PREPARATION

1. Remove all the hardware and mask off anything you don't want painted.
2. Lightly scuff sand the surface with a Scotch Brite pad or fine sandpaper.
3. Wipe the door with acetone to clean any dust or residue from the surface. Allow acetone to dry from the surface before applying primer.
4. Do not use hydrocarbon based solvents to clean the surface as such products may leave a residue.
5. Apply primer with a paint brush. Follow the manufacturer's instructions for drying time before applying topcoat. Continue to apply primer to all 6 sides, include bores and mortises.
6. The primer must be completely dry before applying the topcoat.

STEP 2: PAINTING

1. Apply exterior grade paint with a paint brush.
2. It is common practice to paint both stiles the same color as the exterior side of the door. If applying a second coat, follow the manufacturer's instructions for drying time between coats.

3. Continue to apply the topcoat to all 6 sides. Door panels which have been bored and mortised for hardware should be finished inside of the lock bore as well.

CAUTION

1. Painting Neuma Doors dark colors can result in poor performance. Dark colors are considered any color that falls within the lightness (L) value of 56 to 0. Where 100 is white and 0 is black. Use paint with a light reflective value (LRV) of 57 units or greater.
2. When using stains, mineral spirits, paints, or other hazardous materials, always read and follow the manufacturer's instructions. Neuma Doors makes no representations as to the proper use of other manufacturers' products.
3. When working with paints or solvents, make sure the working area is well ventilated.
4. Keep away from heat and flame as materials may be combustible.
5. Paints or solvents may cause skin and eye irritation. Avoid contact with skin and eyes.
6. Keep out of reach of children.

Maintenance

All well-finished fiberglass doors will be affected by exposure and weathering from sun, moisture, and air pollutants. It is considered normal maintenance to re-apply the topcoat approximately every two years.

STAINING GUIDE

MATERIALS NEEDED

1. Pre-Mixed Stain (1/2 pint)
2. Mineral Spirits (4 fl. oz.)
3. Top Coat/Sealer (20 fl. oz.)
4. Two Clean Cloths
5. One Pair Protective Gloves
6. 3" China Bristle Brush
7. Two Stir Sticks
8. Finishing Instruction



STEP 1: SURFACE PREPARATION

1. If possible, lay door horizontally on a padded surface to prevent scratches.
2. Remove all the hardware and mask off anything you don't want stained.
3. DO NOT SAND WOODGRAINED COMPOSITE.
4. Wipe the door with mineral spirits to clean any dust or residue from the surface. Allow door surface to dry completely before applying stain.

STEP 2: STAIN APPLICATION

Apply stain with a 3" to 4" soft bristle brush, or rag to small sections of the door at a time. Apply enough stain to fill the door grain.

With a clean, lint-free 24 x 24 inch cloth, softly wipe the surface until you reach your desired tone.

TIP: When the rag becomes saturated with stain, re-fold to work with a less-saturated section. Be sure to use the same rag for the whole door.

After all the stain is brushed evenly you may add finishing touches by using a small 1" to 2" brush or cotton swabs. Additional coats may be applied to achieve desired look. Follow all stain manufacturers instructions for proper application (if different) and compatibility information.

STEP 3: PROTECTIVE TOP COAT

Application of a polyurethane top coat with UV inhibitors like ZAR™ Exterior polyurethane, Wood Kote® Flagship UV, or Minwax® Fast Drying Polyurethane for exterior applications.

1. After stain has completely dried (48 hours), mix the top coat well and apply evenly using a clean dry 2" soft bristle brush or 3" foam brush. Be sure to stop when the grain changes direction.
2. Apply two or three coats of finish, allowing at least 24 hours of drying time between each application.

NORMAL MAINTENANCE

Even a well-finished door will be affected by exposure and weathering from sun, moisture, and air pollutants. It is considered normal maintenance to re-apply the topcoat approximately every two years. Due to the variability in finishing materials, application conditions and techniques, all of which are beyond the control of Neuma Doors, Neuma cannot be responsible for the performance of field applied finishes or individual application techniques.

* Staining instructions are for Oil-Based, Premium Quality Stains or similar product designed for use on fiberglass. Please note the instructions indicated are specific to the Zar brand stain. Please reference stain manufacturers instructions before applying any stain.

OXIDATION/CHALKING CLEANING GUIDE



Composite and fiberglass products are low-maintenance and easy to care for, they will perform their best with some occasional attention. In rare cases, products can be affected by solar energy or chemicals that can cause a change in color - including fading, darkening or yellowing. In most climates and with many mild chemicals, a change may not even be noticed. In other cases, however, the color change may be more dramatic and become cause for concern.

A chalky white substance on your patio doors panels maybe caused by oxidation, which occurs most often during damp or wet weather. Oxidation can be cleaned from most doors, but the process can be time-consuming and labor-intensive.

Suggested cleaning and maintenance

1. Rinse with a light spray of water to remove dust, dirt and debris. Use a garden hose and spray the water downward to avoid getting any beneath the door panels, where it can damage the floor beneath.
2. Wear safety glasses to avoid spraying cleaning solution into your eyes as you work. Mix 5 cups of vinegar into 1 gallon of hot water, and pour some of this solution into a spray bottle.



3. Apply the vinegar and water solution onto a small section of trim and scrub with a long-handle, soft-bristle cleaning brush. Work from the bottom of the trim up to avoid streaking. Sections of about 10 feet or less are usually easier to work with than larger sections, because the vinegar and water solution won't have time to dry on the panels before you rinse.
4. Hose off the trim with a gentle spray of clean water, again spraying downward.
5. Continue to spray and scrub the oxidation until you have cleaned all of the trim. Use a ladder to reach sections of trim on the upper levels of your home.
6. HPVD handle sets should be wiped down with a non-abrasive, clean, damp cloth once a month. The protective coating on the HPVD handle sets naturally have a dull appearance. Do not attempt to polish the HPVD handle set as it will destroy the protective finish.

MAINTENANCE GUIDE



1. Vacuum dirt and debris from sill and track areas before washing
2. Clean glass and door frame with a mixture of mild dish soap and water. Rinse completely with clean water and wipe dry with a soft cloth to avoid water spots.
3. Avoid washing glass in direct sunlight.
4. Never use abrasive or caustic cleaners. They can cause permanent damage to the frame finish or the glass.
5. Mild, nonabrasive soaps are usually the safest for most dirt and stain removal, but any cleaner you use should be tested in an inconspicuous area first.
6. Always rinse completely with clear water and wipe dry if possible.
7. Check to make sure drainage or “weep” holes are always clear of dirt and obstructions - both inside and outside the door in the bottom of the frame.
8. Clean screens by removing them, washing them on a flat, clean surface with mild soap and water and a soft brush. Then rinse, wipe dry and reinstall.
9. Doors with moving parts include hardware components that should be lubricated periodically. In salt-air environments, these components require monthly lubrication.
10. After wiping clean, use a silicone spray with a non-petroleum-based propellant on door or sliding door tracks, rollers and locking hardware



Ideal Construction Practices



For optimum performance of your Neuma Door, it is important to follow sound construction practices when installing the door. Neuma Doors are designed to protect against water infiltration, however, there are steps that can be taken during the installation process in order to provide complete protection to your home. Be sure to acquaint yourself with local building codes and follow all recommendations of your building professional.



Adequate Overhangs

Before construction begins, it is important to plan the placement of your door. Over time, a door can be compromised by extended direct exposure to the weather. When considering the placement of the door, it is important to consider the placement of the door and what type of protection the building construction can provide for the door. An appropriate overhang over your door will help extend the finish of the door and protect the door from weather intrusion.

Plumb, Level and Square

Prior to installing the door, it is critical to ensure that the rough opening for the door is flat, level, square, plumb and free of debris for optimal door operation. As you continue through the installation process, verify at each step that the door is plumb, level and square.

Sill Pan

Use of an optional sill pan is recommended to prevent water from seeping in and to protect the subfloor beneath the door. The appropriate use of a sill pan can greatly reduce the chance of water intrusion beneath the door.

Non-Structural Nailing Fin

Neuma Doors provides a non-structural nailing fin to assist with the installation of the door and to provide an additional layer of weather protection.

Drip Cap

Installing a drip cap is a simple way to protect your home from water. Easily installed, drip caps are designed to drain water away before it reaches the door unit

Weather Barrier

Use of an appropriate flashing or waterproof barrier applied around the door opening to the top of the nailing fin is required. This weather barrier prevents water from dripping behind the nailing fin and into the structure of the wall.



The Ivy - River Oaks 2303 Mid Lane, Houston TX





Limited Lifetime Warranty

For full warranty information, exclusions, limitations, and warranty service request procedures, please visit <http://www.neumadoors.com/pdf/warranty.pdf>.

NANYA PLASTICS CORPORATION USA OFFERS A NON-TRANSFERABLE LIMITED LIFETIME WARRANTY OF THE NEUMA PATIO DOOR SYSTEM AGAINST: DEFECTS IN MATERIALS AND WORKSMANSHIP INCLUDING; PEELING, CRACKING AND DELAMINATION. PROPER MAINTENANCE IS REQUIRED. IT DOES NOT COVER VARIATIONS OR CHANGES IN THE COLOR OF THE DOOR PANEL INCLUDING BUT NOT LIMITED TO CHALKING AND DISCOLORATION. SHOULD SUCH CHANGES OCCUR, PANELS MAY BE PAINTED ACCORDING TO MANUFACTURER INSTRUCTIONS. DOOR TRIM AND HANDLE FINISH ARE NOT COVERED. THIS LIMITED WARRANTY IS IN LIEU OF AND EXCLUDES ALL OTHER WARRANTIES NOT EXPRESSLY SET FORTH, EXPRESS OR IMPLIED BY OPERATION OF LAW OR OTHERWISE, INCLUDING WITHOUT LIMITATION TO ANY IMPLIED WARRANTIES OF MERCHANTABILITY OR FITNESS FOR A PARTICULAR PURPOSE. TO THE EXTENT THAT ANY IMPLIED WARRANTIES MAY NONETHELESS EXIST BY OPERATION OF LAW, SUCH WARRANTIES ARE LIMITED TO THE DURATION PROVIDED BY LAW.

THE LIMITATIONS ON THE LENGTH OF IMPLIED WARRANTIES VARY FROM STATE TO STATE AND THEREFORE, SUCH LIMITATIONS MAY NOT BE APPLICABLE IN YOUR STATE.

Subject to the conditions, exclusion and limitations contained herein, Nan Ya Plastics Corporation USA warrants that the Neuma Patio Door System is free from defects in materials and workmanship from the date of original installation when it has been properly installed in compliance with the manufacturer's installation instructions.

Warranty Coverages During the First Year

Nan Ya Plastics Corporation USA will repair or replace any factory defective door system components or parts at no charge, during the first year after installation.

Warranty Coverages After the First Year

After the first year, replacement parts may be provided at no cost (if found to be a warrantable item), but there is no coverage of labor charges for the removal of defective products or for installation of replacement products. Nan Ya Plastics Corporation USA does not have responsibility, liability, or obligation for, nor will it pay for any removal or installation labor costs for the replacement product.

Warranty Details for Neuma Door Systems in Owner-Occupied Single Family Homes

This Non-Transferable Limited Warranty applies only to the Neuma Patio Door System installed by a licensed and bonded contractor in original owner-occupied single-family detached homes within the United States.

Warranty Coverages for Neuma Door System Components Installed in Owner-Occupied Single Family Homes

1. Door frames: Lifetime for original purchaser as long as purchaser owns home.
2. Mullions: Lifetime for original purchaser as long as purchaser owns home.
3. Astragals: Lifetime for original purchaser as long as purchaser owns home.
4. Door panels: Lifetime for original purchaser as long as purchaser owns home.
5. Transom Frames: Lifetime for original purchaser as long as purchaser owns home.
6. Locking Mechanism: 10 years for the original purchaser, excludes trim finish.
7. Factory Painted Finish:
 - 2 years for the original purchaser against deficiencies of blistering, cracking, peeling or loss of adhesion.
 - Warranty on painted finish applies only to doors that are factory painted by Nan Ya Plastics Corp. USA.
 - Slight imperfections in factory applied finishes; surface cracks that do not compromise the underlying material are not

considered a defect.

8. Folding Door System Hardware and Components:
 - Folding door system hardware: 10 years for the original purchaser, excludes finish
 - All hardware should be maintained as recommended in the care instructions as frequently as necessary.
 - Hardware in coastal environments should be maintained every three months as a minimum and more frequently if necessary.
9. Glass Components:
 - NonImpact Glass: 20 year prorated limited warranty against seal failure.
 - Impact Glass: 10 year prorated limited warranty against seal failure.
 - Glass with Mini Blinds: 5 year prorated limited warranty against seal failure only and 1 year warranty of the magnetic components.
 - Decorative Glass: 1 year limited warranty against seal failure. Due to the nature of decorative glass, it is expected that there will be slight inconsistencies in coming and beveled glass pieces. Such inconsistencies are not warrantable.

Nan Ya Plastics Corporation USA warrants that insulated glass shall be free from any failure or material obstruction of vision due to a failure of the glass seal for the warranty period.

A failed glass seal is defined as one that shows a significant amount of obstruction due to moisture created by a seal failure. Small marks, scratches, and spots which do not exceed company standards or federal government specifications, C 1036-85 do not make insulated glass units defective. See glass warranty chart for more information.

Warranty Details for Neuma Door Systems in Multi-Family and Commercial Applications

This Non-Transferable Limited Warranty applies only to the Neuma Patio Door System installed by a licensed and bonded contractor in (1) residential applications other than original owner-occupied single-family detached homes, and (2) commercial applications within the United States

Warranty Coverage for Neuma Door System Components Installed in Residential and Commercial Applications

1. Door frames: 10 years from date of installation.
2. Mullions: 10 years from date of installation.
3. Astragals: 10 years from date of installation.
4. Door panels: 10 years from date of installation.
5. Transom frames: 10 years from date of installation.
6. Locking Mechanism: 5 years from the date of installation, excludes trim finish.
7. Factory Painted Finish:
 - 2 years for the original purchaser against deficiencies of blistering, cracking, peeling or loss of adhesion.
 - Warranty on painted finish applies only to doors that are factory painted by Nan Ya Plastics Corp. USA.
 - Slight imperfections in factory applied finishes; surface cracks that do not compromise the underlying material are not considered a defect.
8. Folding Door System Hardware and Components:
 - Folding door system hardware: 10 years for the original purchaser, excludes finish
 - All hardware should be maintained as recommended in the care instructions as frequently as necessary.
 - Hardware in coastal environments should be maintained every three months as a minimum and more frequently if necessary.
9. Glass Components:
 - NonImpact Glass: 20 year prorated limited warranty against seal failure.
 - Impact Glass: 10 year prorated limited warranty against seal failure.
 - Glass with Mini Blinds: 5 year prorated limited warranty against seal failure only and 1 year warranty of the magnetic components.
 - Decorative Glass: 1 year limited warranty against seal failure. Due to the nature of decorative glass, it is expected that there will be slight inconsistencies in coming and beveled glass pieces. Such inconsistencies are not warrantable.

Nan Ya Plastics USA warrants that insulated glass shall be free from any failure or material obstruction of vision due to a failure of the glass seal for the warranty period. A failed glass seal is defined as one that shows a significant amount of obstruction due to moisture created by a seal failure. Small marks, scratches, and spots which do not exceed manufacturer standards or federal government specifications, C 1036-85 do not make insulated glass units defective. See glass warranty chart for additional information.

Warranty Exclusions

Generally, Nan Ya Plastics Corp. USA, d/b/a Neuma Doors does not cover normal wear and tear, or damage resulting from improper installation, misuse, abuse, neglect, improper maintenance, and alterations or damage caused by others. Doors must be properly maintained to preserve their appearance. Nan Ya Plastics Corporation USA does not have responsibility, liability, or obligation, for property damages arising from a Warranty claim on a Neuma Door System. Maintenance guide can be found at <http://www.neumadoors.com/pdf/Maintenance.pdf>.





NAN YA PLASTICS CORP. USA
D.B.A Neuma Doors

8989 North Loop East HOUSTON, Texas 77029

Toll free : 1-866-Doors-15 1-866-366-7715 Fax : 1-888-862-6555

www.neumadoors.com